

FlexStyle™ Battery

Long-lasting, rechargeable battery for FlexStyle window shade

INSTRUCTIONS

INSTALLATION & OPERATION

Overview - Components

FLEXSTYLE BA

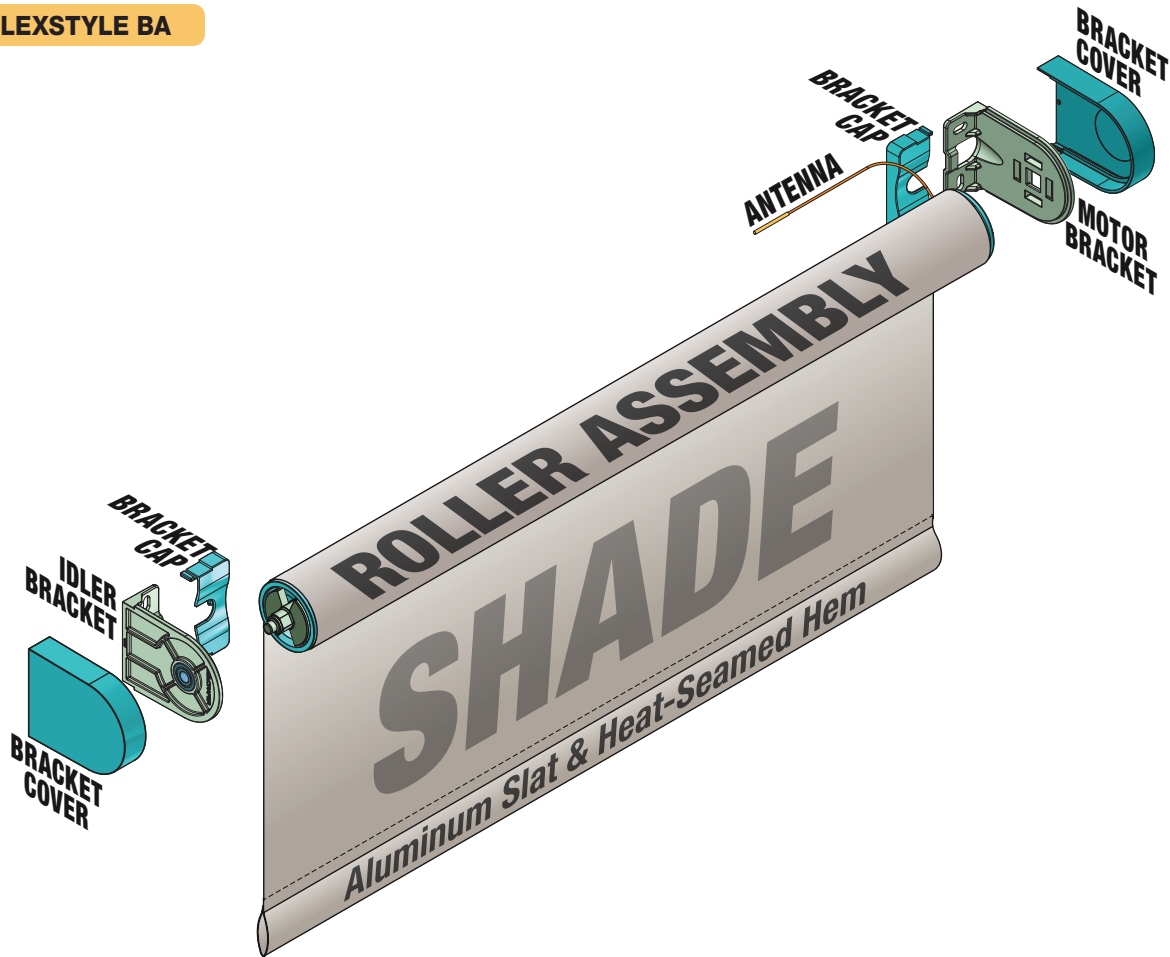

TOOLS REQUIRED



PENCIL



POWER DRILL

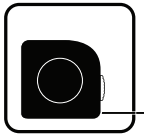

TAPE MEASURE

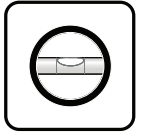

LEVEL



HARDWARE (by others)



PLIERS

⚠ CAUTION ⚠

Read and understand all warnings (Page 2 of this document) before beginning installation.

Contents

Overview - Components.....	1	Section 4 - RF Remote Programming Instructions	5
PLEASE READ - Important Safety & Installation Information	2	Section 5 - Activate/Deactivate Radio Technology Somfy® (RTS)	6
PLEASE READ - Field Adjustments, Cleaning and Maintenance.....	2	Section 6 - Adjusting the Speed	6
Section 1 - Installing Mounting Brackets.....	3	Section 7 - Removing Bracket Covers (Must be ordered separately).....	7
Section 2 - Charging Battery.....	3	Section 8 - Bracket Dimensions	7
Section 3 - Mounting Shade.....	4	Section 9 - Shade Dimensions.....	8

If you have any difficulties installing or servicing your FlexStyle® Battery shade, call your dealer or Draper, Inc.

PLEASE READ - Important Installation Information

⚠ Caution:

1. Inspect all boxes to make sure you have received the proper shades and parts. Controls may be shipped separately, or in same carton as shades.
2. Open cartons lengthwise.
3. Before mounting shades, verify measurements on label provided with shade, and ensure unit is installed at correct width.
4. Before connecting switches, controls, or electrical, ensure that power is turned **OFF**. Wiring indicated in diagram by dashed lines must be completed by an electrician.
5. Do not wire motors in parallel without written permission from Draper.
6. All hardware must be installed level. Shades must be level and square.
7. **Read the following installation guidelines thoroughly and follow them carefully. Failure to do so may cause product to fall or otherwise fail, and invalidates warranty.**
8. **Installer is responsible for selecting mounting hardware appropriate for site conditions.**

PLEASE READ - Safety Information

Important Safety Information



Important Safety Information

Improper installation and use of the FlexStyle® Li-Ion can result in serious injury or death. Primarily, injuries can occur if the unit falls due to imprecise installation, mishandling of the unit during installation, or installation on an insufficient wall or ceiling structure. Please use extreme care.

1. Please read the following installation guidelines thoroughly and follow them carefully. Failure to do so may cause product to fall or otherwise fail, and could result in serious injury.
2. Installation and calibration of the unit should only be performed by an authorized, qualified, and experienced professional.
3. Do not affix the unit to wall or ceilings that have inadequate strength to permanently hold the unit during use. It is the owner's and installer's responsibility to confirm the wall or ceiling to which the unit attaches is sufficient to permanently hold the weight and stress loads of the unit at all times. Draper, Inc., is not responsible for improper installation, application, testing, or workmanship related to the product at place of installation.
4. It is the installer's responsibility to make sure appropriate fasteners are used for mounting.
5. All hardware must be installed level. Unit must be level and square.
6. Never leave the area while operating the unit during installation, maintenance, or normal operation, unless it is secure and safe.
7. Before testing or operation, carefully inspect the entire area and path of the shade and areas underneath the shade to be sure no persons or objects are in the area.
8. Make sure the limit switches are pointed down or accessible when placing the motor in brackets/endcaps.
9. During testing or operation, carefully watch the surrounding area for any potential safety concerns including nearby persons or objects.
10. After installation, the entire system, including all sensors, should be carefully tested to ensure safe and normal operation. Extreme care should be taken during testing to remain clear of moving parts to avoid possible injury.
11. Operation of unit should be performed only by authorized and qualified personnel, who have been trained in the safe and effective operation of the unit and understand its safety features.
12. The safety features of the unit, including sensors, should never be disabled, bypassed, or overridden. The system should not be operated until all safety features, including the sensors, are properly and completely installed, calibrated, and tested.
13. Unit may need to comply with local, state, or district rules and regulations, in particular when installed in schools. All applicable rules and regulations should be reviewed before installation and use.
14. Failure to precisely follow installation guidelines invalidates all warranties.
15. Custom products/installations may not be reflected in this manual. Call Draper®, Inc., if you have questions about the installation of custom products or any questions about your installation.

Before Beginning Installation

1. Look for any job site conditions that could interfere with installation or operation of the system.
2. Read carefully and be sure to understand all installation instructions and all related operations manuals. These instructions are intended to serve as a guide for the installer and owner. They should be followed closely and combined with the expertise of experienced qualified installers. Draper, Inc., is not responsible for improper installation, application, testing, or workmanship related to the product at place of installation. Please retain all instructions for future use.
3. Open cartons lengthwise.
4. Locate and lay out all pieces.
5. Inspect all boxes to make sure you have received the proper shade and parts. Controls may be shipped separately, or in same carton as shade.
6. If you have any difficulties with installing, servicing, or operating your shade, call your dealer or Draper, Inc., 765-987-7999.

PLEASE READ - Field Adjustments

Each Draper Solar Control Shade is tested to ensure proper operation. Even with this testing, some field adjustments may be needed for telescoping.

If the shade is telescoping, place a piece of high quality gaffer tape about 1" (25 mm) wide on the exposed roller (where the fabric will cover it) on the side that the fabric will be drawn toward. For example: if the fabric is tracking to the left, place the tape on the right side.

PLEASE READ - Cleaning and Maintenance

Window covering products manufactured by Draper, when properly installed, should require no operational maintenance or lubrication.

Most of Draper's standard fabrics may be cleaned at the window by vacuuming with a soft brush attachment. They also may be cleaned by using a sponge or soft cloth and mild solution of warm soapy water. A mild dishwashing liquid is recommended. A clean dry cloth is recommended for the metal finish.

Please Note: Exceptions are Flocké and Phifer SW7000 fabrics, which must be cleaned with a dry art sponge.

Section 1 - Installing Mounting Brackets

IMPORTANT: Mounting Brackets must be installed parallel, plumb, and square, with a tolerance of +/- 1/8" (3mm). Verify unit measurements and ensure unit will fit in the desired location.

Please Note: Installer is responsible for selecting mounting hardware appropriate for site conditions.

- 1.** Mark wall or ceiling for placement of mounting brackets. (Idler Bracket shown.)

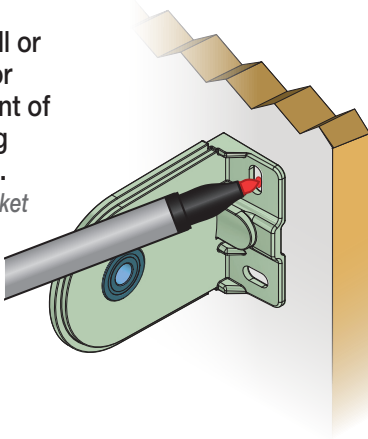

- 2.** Drill small starter hole in mounting surface (if necessary).

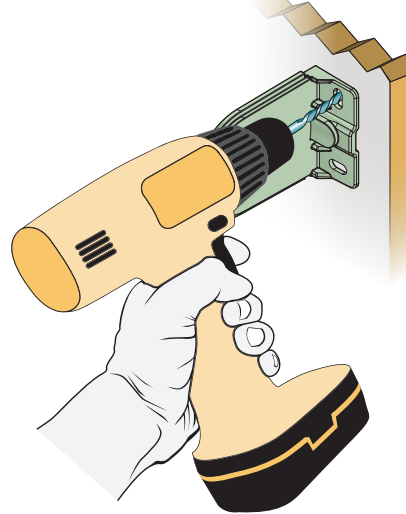

- 3.** Attach brackets using appropriate fasteners (by others) for mounting surface. (Motor Bracket shown.)

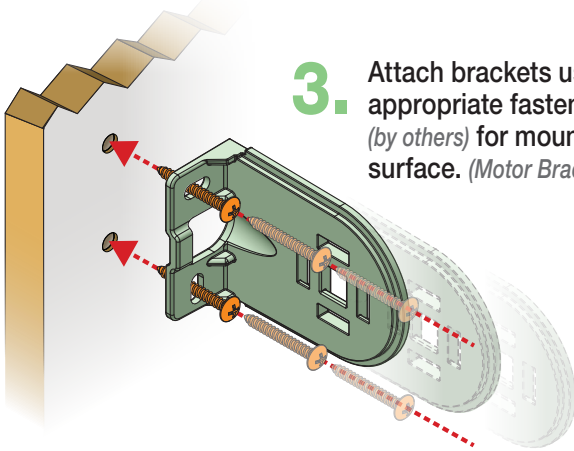

- 4.** Slide the Bracket Cap over bracket. (Motor Bracket shown.)

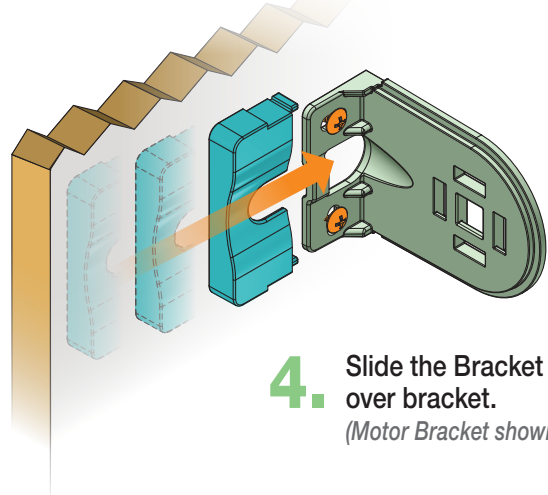

Section 2 - Charging Battery

This motor has a 12V built-in Li-ion battery pack with integrated charge management. Maximum power input for recharging: 12.6V / 1000mAh.

- Once battery has been depleted, motor must be charged for 6 hours using recommended AC charger.
- During operation, if voltage drops to less than 10V, motor will beep 10 times to indicate it needs to be charged.
- Motor will stop running when voltage is lower than 7V and resume when voltage is greater than 7.5V.

⚠ Caution: Ensure antenna wire is kept straight and away from metal objects.

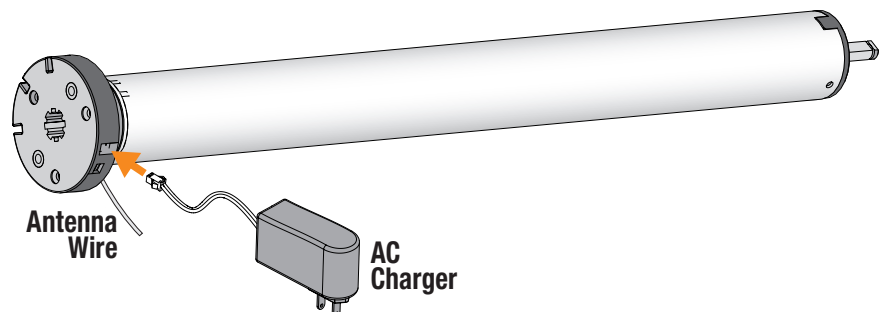

Section 3 - Mounting Shade

Please Note: ALWAYS START AT THE IDLER END OF SHADE.

Please Note: This shade must be mounted to wall or ceiling. No jamb mounting option available.

1. Lift idler end of the fabric/roller assembly into place and align between the brackets.

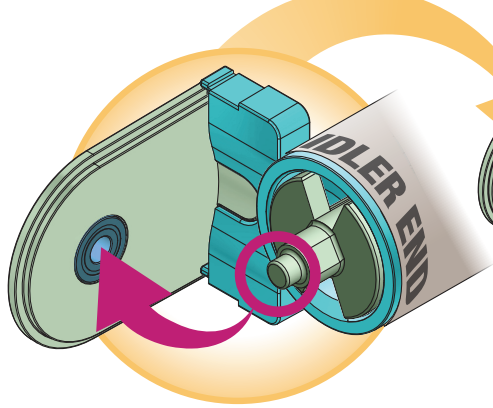

2. Depress spring-loaded end of shade and insert it into hole in Idler Bracket.

3. Feed cable through hole in bracket

4. Hook Motor Plate into hole on the Motor Bracket.

5. Slide Bracket Covers over brackets.

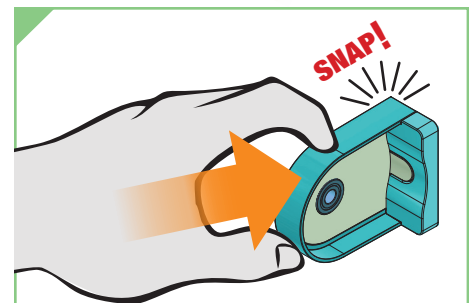

6. Ensure that Bracket Cover SNAPS into place. (Idler Bracket shown.)

Section 4 - RF Remote Programming Instructions

Please Note: The motor ships with no programming. Follow these instructions to program unit to the desired transmitter.

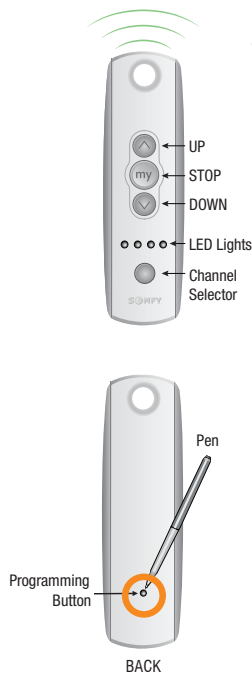

1. Select a transmitter channel to assign motor. Hold UP and DOWN buttons until motor jogs, then release.
2. Check motor direction. To reverse motor direction, hold MY/STOP button for 5 seconds until motor jogs. Check direction again.
3. Move motor to upper limit position. Hold MY/STOP and DOWN buttons until motor moves down, then release. Use UP and DOWN buttons to move shade to correct lower limit and press MY/STOP.
4. While motor is at lower limit, hold UP and MY/STOP buttons until motor moves up, then release. The shade should move to upper limit and stop.
5. Next, hold MY/STOP button until motor jogs.
6. Put motor into USER MODE by briefly pressing small programming button on the back of the transmitter. Motor will jog.
7. If programming additional shades on the same channel, put this motor to sleep until all motors on the same channel are programmed. To put to sleep, hold button on motor head for one jog, release. Then hold UP/STOP/DOWN all at the same time and wait for shade to jog. Motor is now asleep.
8. To wake motor up after putting to sleep, hold button on motor head for 1 second. Shade will jog to indicate it is now awake.

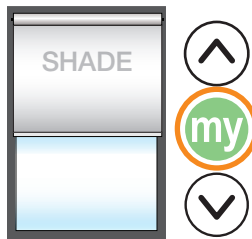
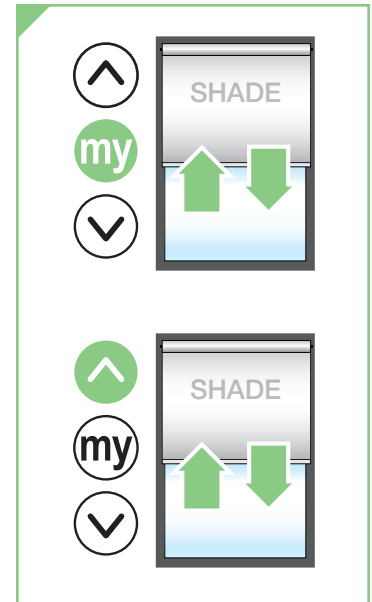

Setting an Intermediate Stop - Shade MUST BE in USER mode.

1. Move shade to desired mid-point location and hold MY/STOP button until motor jogs.
2. To test, press the MY/STOP button when motor is standing still. The shade will move to that intermediate location.
3. To delete an intermediate stop, go to the intermediate stop and hold the MY/STOP button until motor jogs.

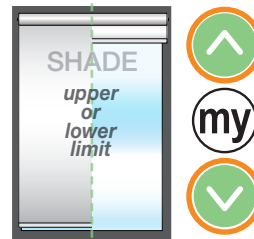

Adjust Limits in User Mode

1. Move motor to limit (*upper or lower*) to be changed. Shade must move to previously set limit and will stop automatically.
2. Hold UP and DOWN buttons until motor jogs.
3. Move motor to its new limit location and hold MY/STOP button until motor jogs.

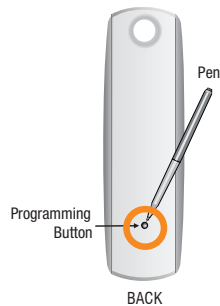

Add a Channel - Shade MUST BE in USER mode.

1. Select channel currently operating motor, then hold programming button until motor jogs.
2. Select new channel to add to motor, then hold programming button until motor jogs.
3. The motor should now work on both the old and new channel.

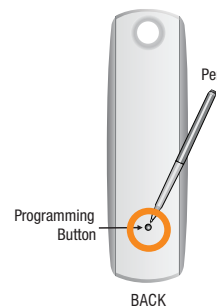

Reset Motor

1. Hold programming button on remote and wait for 3 jogs. Motor is now reset.

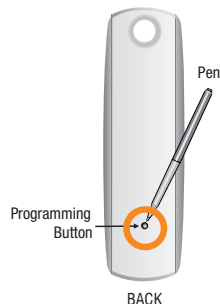

Delete a Channel - Shade MUST BE in USER mode.

1. Select channel operating motor that you want to keep, then hold programming button until motor jogs.
2. Select channel to remove, then hold programming button until motor jogs. Motor should now only work on channel kept from Step 1.

Section 5 - Activate/Deactivate Radio Technology Somfy® (RTS)

Please Note: This function is used to deactivate the radio transmission to save the battery life during shipment, or when the product will not be used for an extended amount of time (eg: storage).

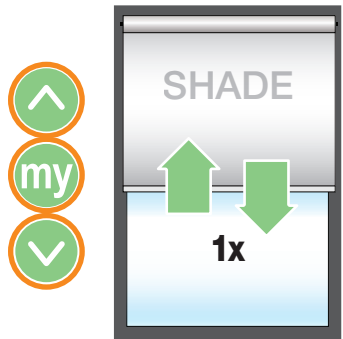

1. To put motor to sleep: Hold motor button for one jog, then hold UP/MY/DOWN and wait for motor to jog once. Motor is now asleep.

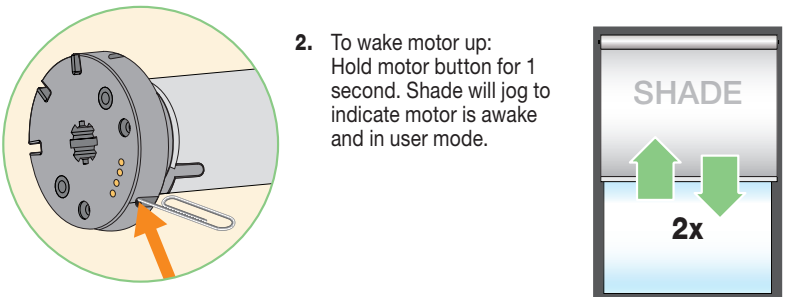

2. To wake motor up: Hold motor button for 1 second. Shade will jog to indicate motor is awake and in user mode.

Section 6 - Adjusting the Speed

Please Note: Orange LED blinks slowly in this mode.

1. Move the shade away from the end limits. Press and hold the UP, MY and DOWN buttons simultaneously, until the shade jogs up and down once. The shade will jog automatically in 10 second cycles and green LED blinks 5 times to validate entering in speed adjustment mode.
2. To increase the speed, press and hold the UP button until the shade jogs up and down once and green LED blinks 5 times. Repeat as needed.

Please Note: Maximum speed is reached when the shade jogs 3 times in one direction and 3 times in the other direction. Red LED blinks 3 times and 3 times intermittently.

3. To decrease the speed, press and hold the DOWN button until the shade jogs up and down once. Repeat as needed.

Please Note: Minimum speed is reached when the driven product moves briefly 3 times in one direction and 3 times in the other direction.

4. To confirm the new speed, press and hold the MY button until the shade jogs up and down once and green LED blinks 5 times.

1



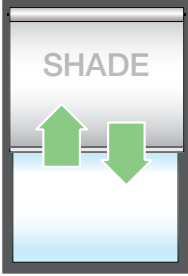



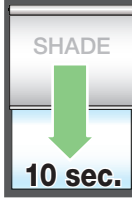
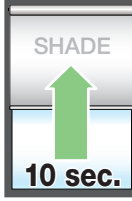



2

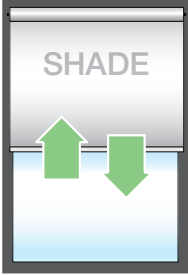



3



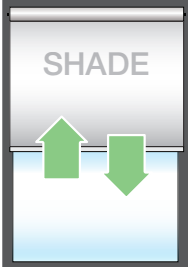

4



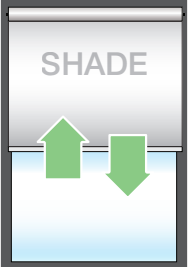

Section 7 - Removing Bracket Covers (Must be ordered separately.)

Please Note: The Cover Removal Tool (Part Number C202.053) is available if bracket covers need to be detached for any reason.

1. Grasp the flat end of the bracket.
(Motor Bracket shown.)

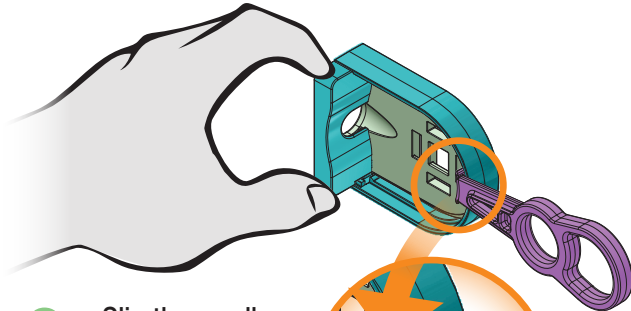

2. Slip the small curved end of the tool under the curved end of the bracket.

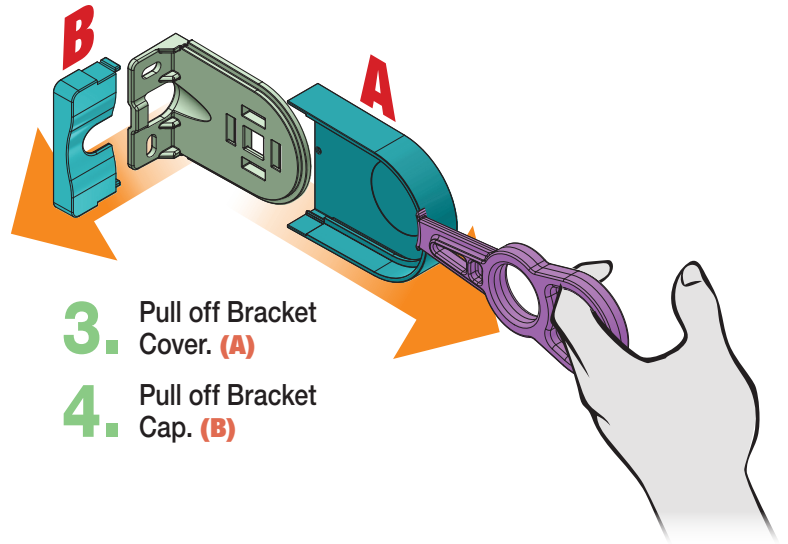

3. Pull off Bracket Cover. (A)
4. Pull off Bracket Cap. (B)

Section 8 - Bracket Dimensions

C002.1822 (Idler End, Extended)

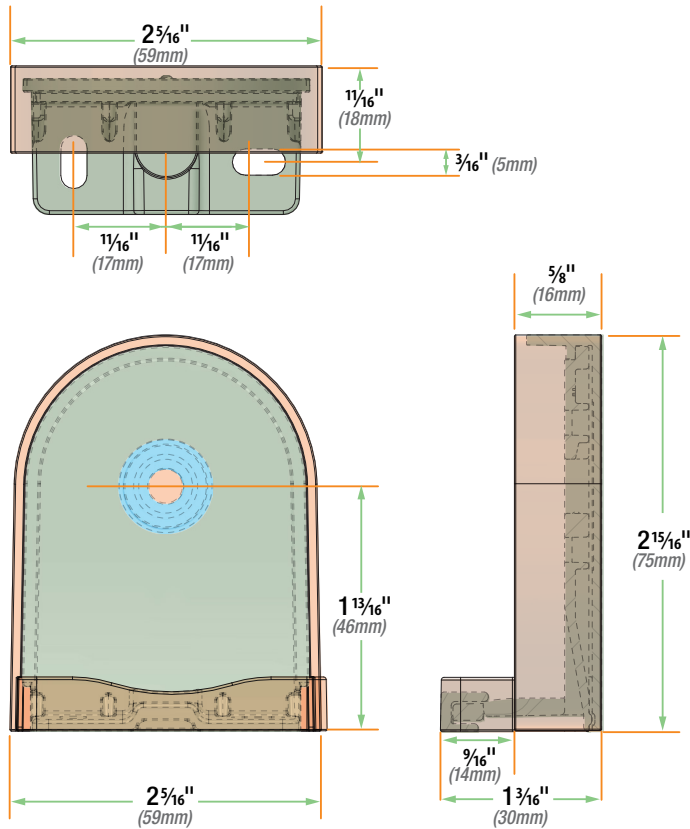

C002.1820 (Motor End, Extended)

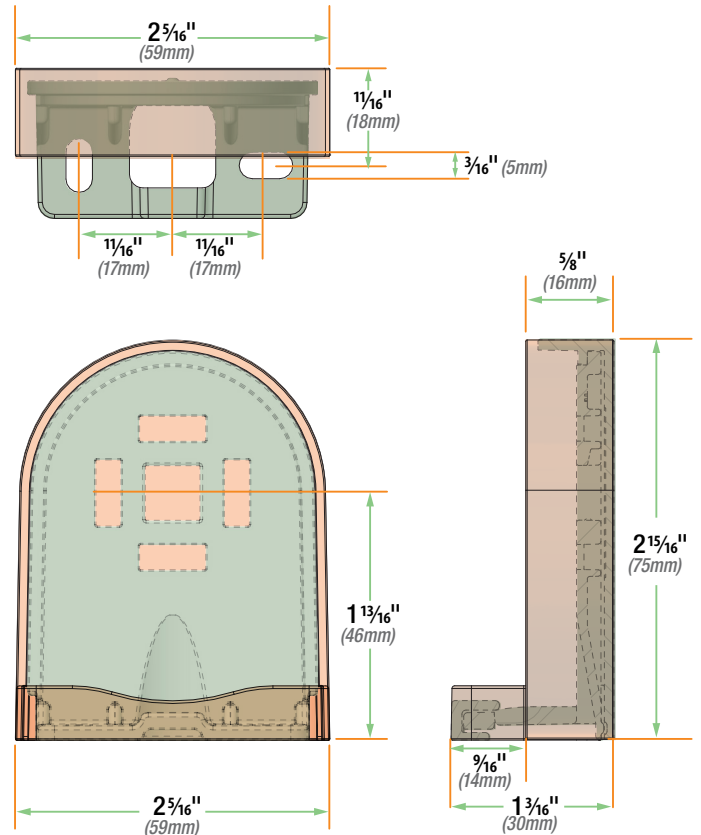

Section 9 - Shade Dimensions

