

FlexStyle™ Recharge

Rechargeable motorized window shade with no wiring or electrician needed

INSTRUCTIONS INSTALLATION & OPERATION

Overview - Components

FLEXSTYLE RECHG

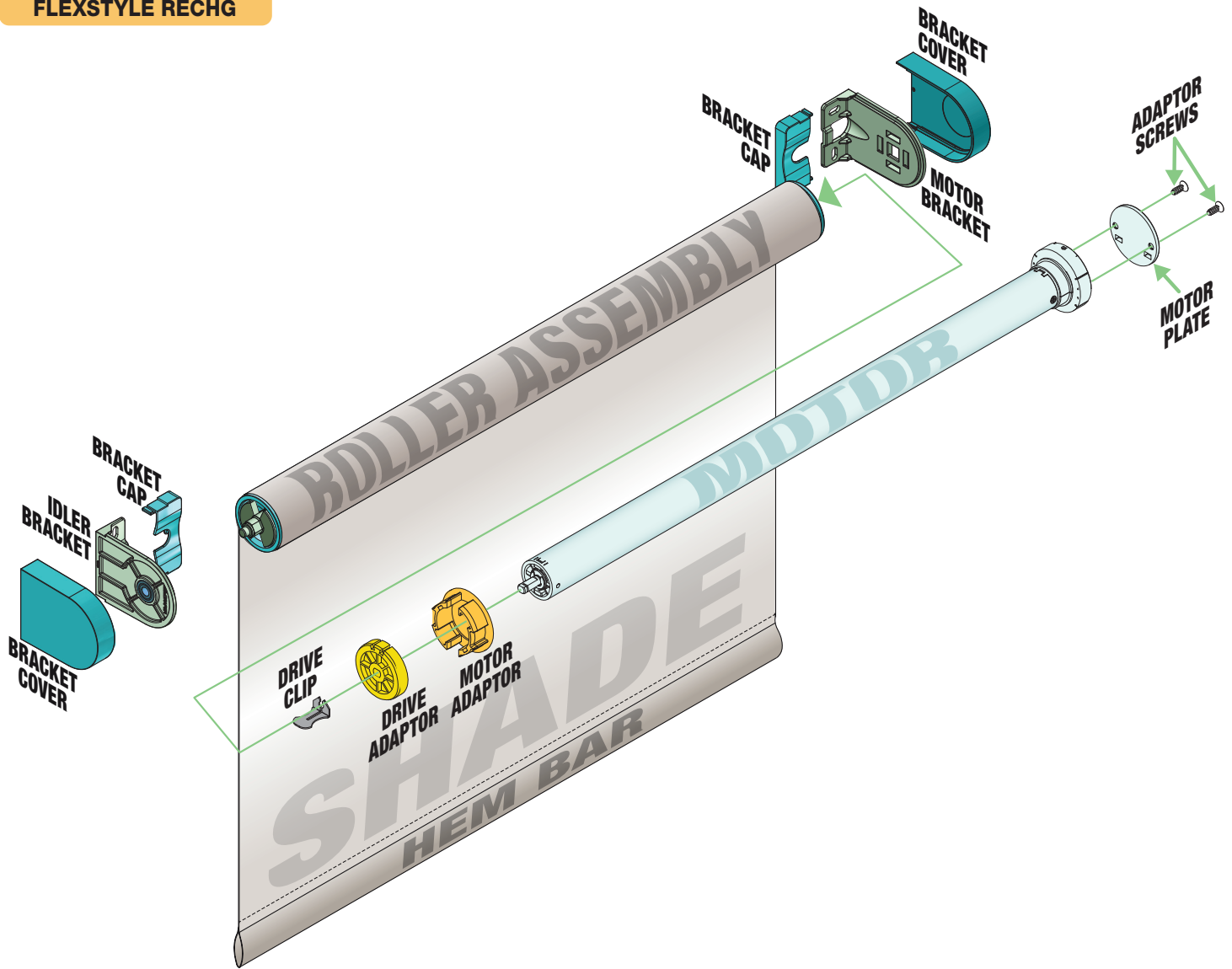

TOOLS REQUIRED

- PENCIL
- TAPE MEASURE
- LEVEL
- POWER DRILL
- PLIERS
- HARDWARE (by others)

⚠ CAUTION ⚠
Read and understand all warnings before beginning installation.

Contents	
Overview - Components.....	1
PLEASE READ - Important Safety & Installation Information	2
PLEASE READ - Field Adjustments, Cleaning and Maintenance.....	2
Section 1 - Installing Mounting Brackets.....	3
Section 2 - Mounting Shade.....	4
Section 3 - Removing Bracket Covers.....	5
Section 4 - Charging Battery.....	5
Section 5 - Remote Controller	5
Section 6 - Initial Motor Setup	6
Section 7 - Motor Limits.....	7
Section 8 - Bracket Dimensions	10
Section 9 - Shade Dimensions.....	10

If you have any difficulties installing or servicing your FlexStyle Recharge, call your dealer or Draper, Inc.



Draper, Inc. | 411 S. Pearl St. Spiceland, IN 47385
draperinc.com | 765.987.7999 | 800.238.7999

© 2024 All Rights Reserved | FORM: FlexStyle_Recharge_Inst24

PLEASE READ - **Important Installation Information**

⚠ Caution:

1. Inspect all boxes to make sure you have received the proper shades and parts. Controls may be shipped separately, or in same carton as shades.
2. Open cartons lengthwise.
3. Before mounting shades, verify measurements on label provided with shade, and ensure unit is installed at correct width.
4. All hardware must be installed level. Shades must be level and square.
5. Read the following installation guidelines thoroughly and follow them carefully. Failure to do so may cause product to fall or otherwise fail, and invalidates warranty.
6. Installer is responsible for selecting mounting hardware appropriate for site conditions.

PLEASE READ - **Safety Information**

Important Safety Information



Important Safety Information

Improper installation and use of the FlexStyle™ Recharge can result in serious injury or death. Primarily, injuries can occur if the unit falls due to imprecise installation, mishandling of the unit during installation, or installation on an insufficient wall or ceiling structure. Please use extreme care.

1. Please read the following installation guidelines thoroughly and follow them carefully. Failure to do so may cause product to fall or otherwise fail, and could result in serious injury.
2. Installation and calibration of the unit should only be performed by an authorized, qualified, and experienced professional.
3. Do not affix the unit to wall or ceilings that have inadequate strength to permanently hold the unit during use. It is the owner's and installer's responsibility to confirm the wall or ceiling to which the unit attaches is sufficient to permanently hold the weight and stress loads of the unit at all times. Draper®, Inc., is not responsible for improper installation, application, testing, or workmanship related to the product at place of installation.
4. It is the installer's responsibility to make sure appropriate fasteners are used for mounting.
5. All hardware must be installed level. Unit must be level and square.
6. Never leave the area while operating the unit during installation, maintenance, or normal operation, unless it is secure and safe.
7. Before testing or operation, carefully inspect the entire area and path of the shade and areas underneath the shade to be sure no persons or objects are in the area.
8. Make sure the limit switches are pointed down or accessible when placing the motor in brackets/endcaps.
9. During testing or operation, carefully watch the surrounding area for any potential safety concerns including nearby persons or objects.
10. After installation, the entire system, including all sensors, should be carefully tested to ensure safe and normal operation. Extreme care should be taken during testing to remain clear of moving parts to avoid possible injury.
11. Operation of unit should be performed only by authorized and qualified personnel, who have been trained in the safe and effective operation of the unit and understand its safety features.
12. The safety features of the unit, including sensors, should never be disabled, bypassed, or overridden. The system should not be operated until all safety features, including the sensors, are properly and completely installed, calibrated, and tested.
13. Unit may need to comply with local, state, or district rules and regulations, in particular when installed in schools. All applicable rules and regulations should be reviewed before installation and use.
14. Failure to precisely follow installation guidelines invalidates all warranties.
15. Custom products/installations may not be reflected in this manual. Call Draper, Inc., if you have questions about the installation of custom products or any questions about your installation.

Before Beginning Installation

1. Look for any job site conditions that could interfere with installation or operation of the system.
2. Read carefully and be sure to understand all installation instructions and all related operations manuals. These instructions are intended to serve as a guide for the installer and owner. They should be followed closely and combined with the expertise of experienced qualified installers. Draper, Inc., is not responsible for improper installation, application, testing, or workmanship related to the product at place of installation. Please retain all instructions for future use.
3. Open cartons lengthwise.
4. Locate and lay out all pieces.
5. Inspect all boxes to make sure you have received the proper shade and parts. Controls may be shipped separately, or in same carton as shade.
6. If you have any difficulties with installing, servicing, or operating your shade, call your dealer or Draper, Inc., 765-987-7999.

PLEASE READ - **Field Adjustments**

Each Draper Solar Control Shade is tested to ensure proper operation. Even with this testing, some field adjustments may be needed for telescoping.

If the shade is telescoping, place a piece of shimming fabric into the fabric roll when the shade is deployed on the side that the fabric will be drawn toward. For example: if the fabric is tracking to the left, place the shimming fabric on the right side.

PLEASE READ - **Cleaning and Maintenance**

Window covering products manufactured by Draper, when properly installed, should require no operational maintenance or lubrication.

Most standard Draper fabrics may be cleaned at the window by vacuuming with a soft brush attachment. They also may be cleaned by using a sponge or soft cloth and mild solution of warm soapy water. A mild dishwashing liquid is recommended. A clean dry cloth is recommended for the metal finish.

Please Note: Exceptions are GreenScreen Evolve®, GreenScreen Revive®, and Phifer® SW7000 fabrics, which must be cleaned with a dry art sponge.
(GreenScreen Revive® and GreenScreen Evolve® are registered trademarks of Mermet® USA. SheerWeave® is a registered trademark of Phifer® Incorporated.)

Section 1 - Installing Mounting Brackets

IMPORTANT: Mounting Brackets must be installed parallel, plumb, and square, with a tolerance of $\pm 1/8"$ (3mm). Verify unit measurements and ensure unit will fit in the desired location.

Please Note: Installer is responsible for selecting mounting hardware appropriate for site conditions.

1. Mark wall or ceiling for placement of mounting brackets. (Idler Bracket shown.)

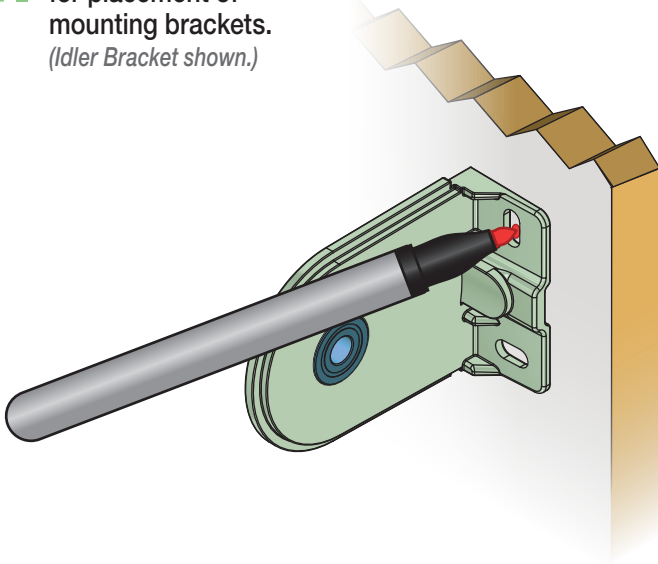

2. Drill small starter hole in mounting surface (if necessary).

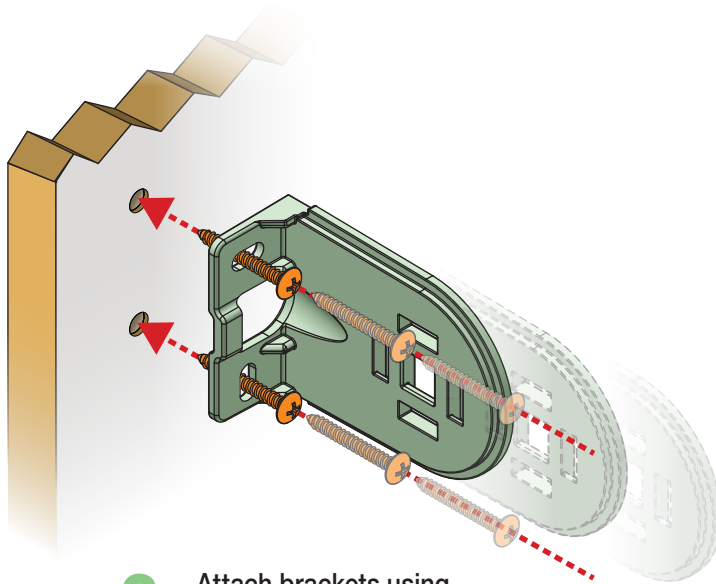

3. Attach brackets using appropriate fasteners (by others) for mounting surface. (Motor Bracket shown.)

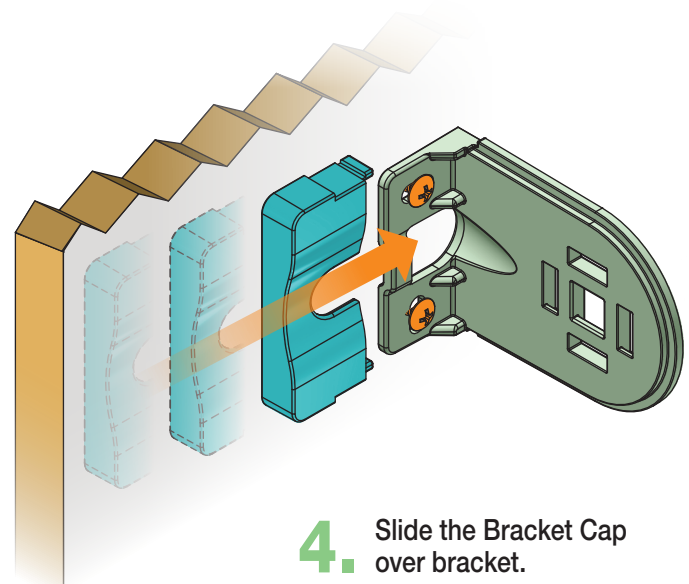

4. Slide the Bracket Cap over bracket. (Motor Bracket shown.)

Section 2 - Mounting Shade

Please Note: ALWAYS START AT THE IDLER END OF SHADE.

Please Note: This shade must be mounted to wall or ceiling. No jamb mounting option available.

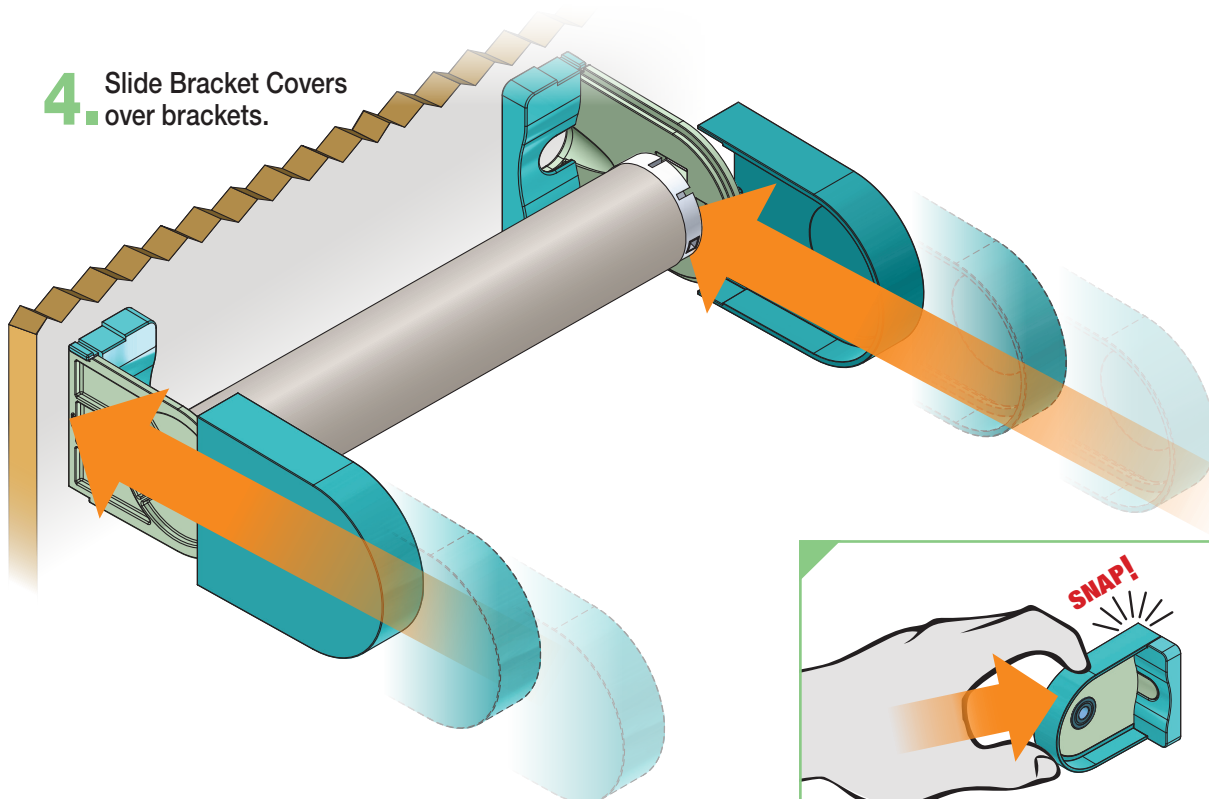
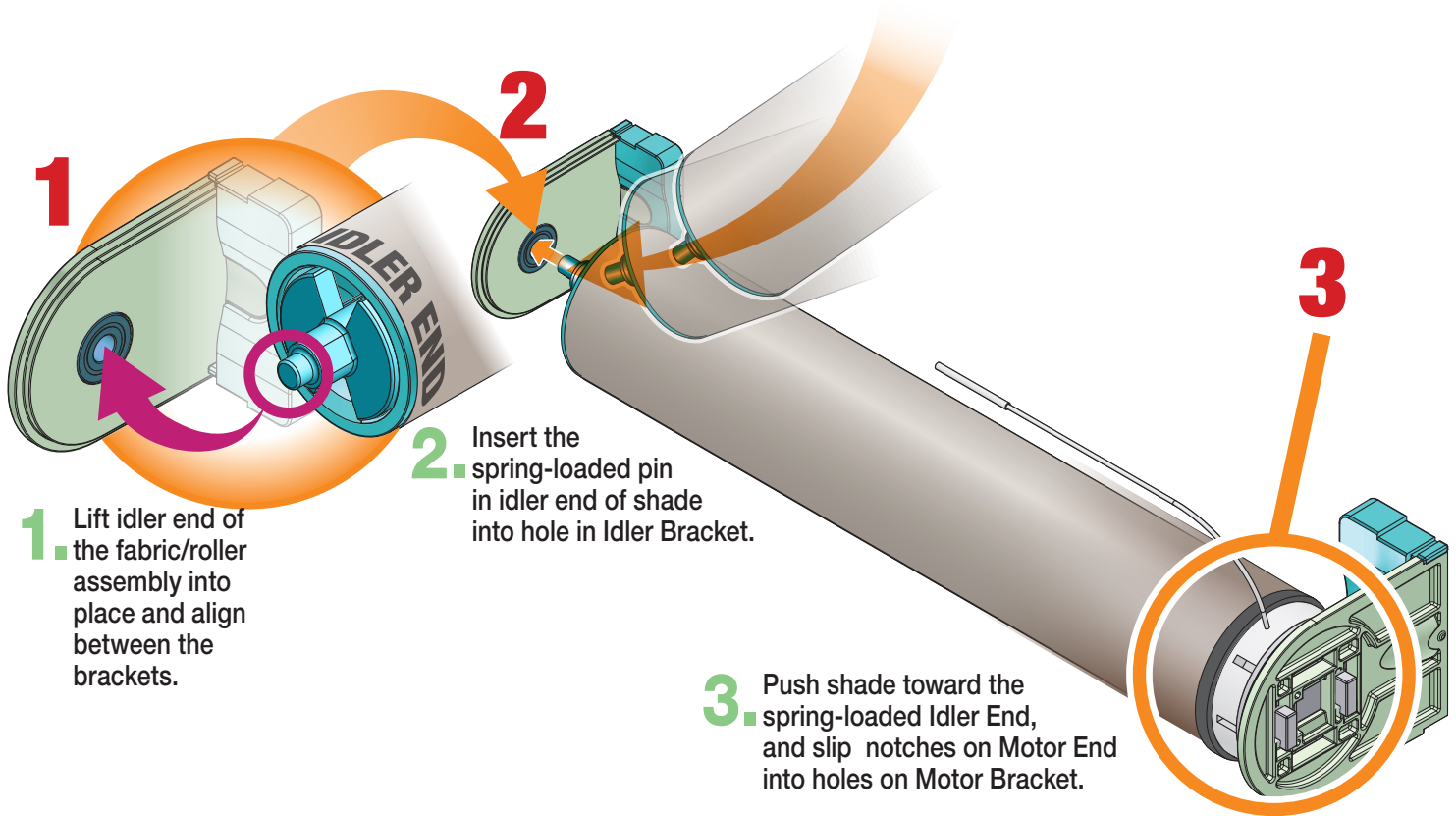

Section 3 - Removing Bracket Covers (Removal Tool must be ordered separately.)

Please Note: The Cover Removal Tool (Part Number C202.053) is available if bracket covers need to be detached for any reason.

1. Grasp the flat end of the bracket.
(Motor Bracket shown.)

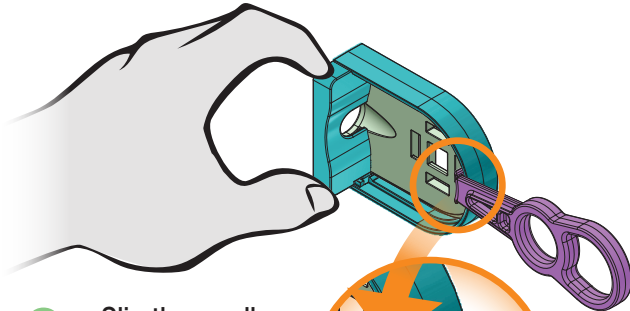

2. Slip the small curved end of the tool under the curved end of the bracket.

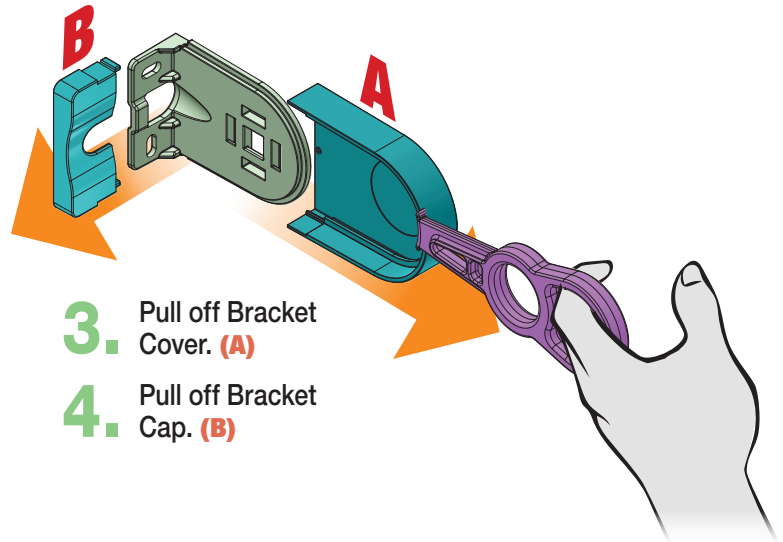
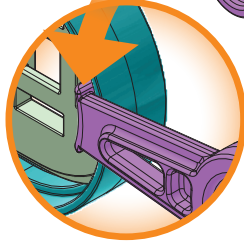

3. Pull off Bracket Cover. (A)
4. Pull off Bracket Cap. (B)

Section 4 - Charging Battery

This motor has a 5V built-in Li-ion battery pack with integrated charge management. Motor arrives charged from factory.

- Once battery has been depleted, motor must be charged for 6 hours using recommended AC charger.
- Determine the motor's battery level using any of the controller's one-touch battery-check functions.

⚠ Caution: Ensure cable is kept clear of fabric. Ensure antenna is kept straight and away from metal objects.

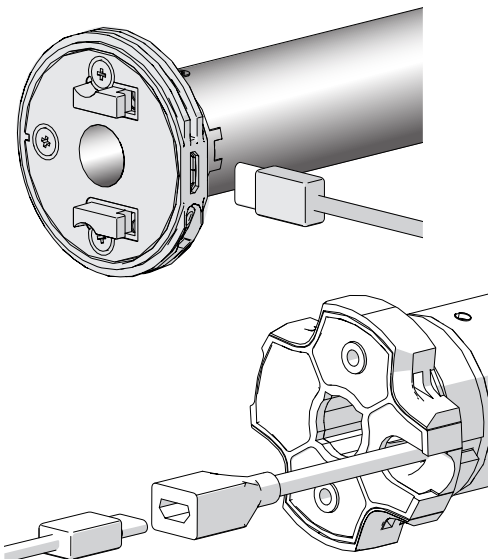

Section 5 - Remote Controller

Scan code with your smart-phone to view a playlist of FlexStyle™ Recharge limit setting videos. These videos do not replace the written instructions, but offer valuable help.

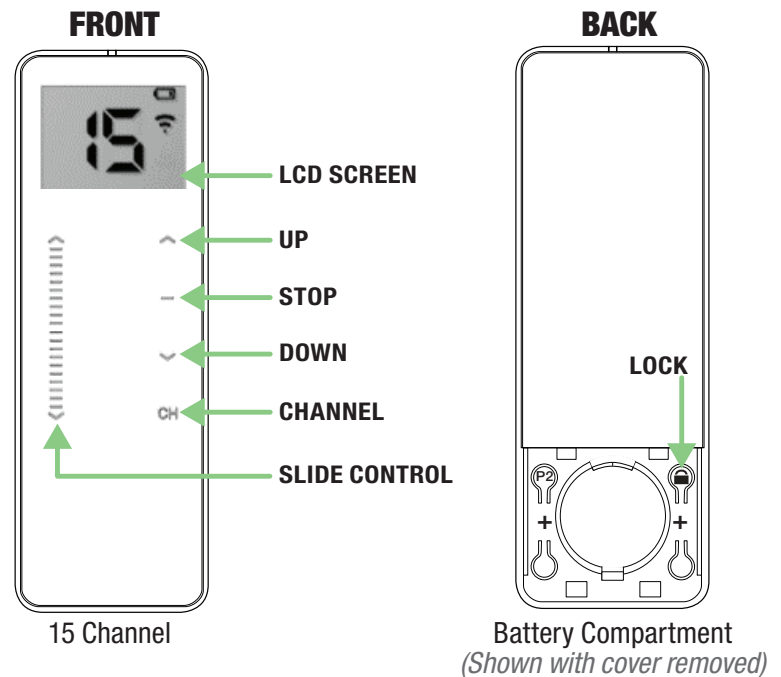
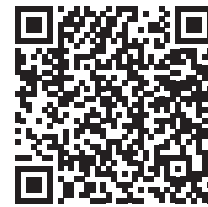

Section 6 - Initial Motor Setup

15 Channel Remote

Press lock button for 1 second or less to display current mode.

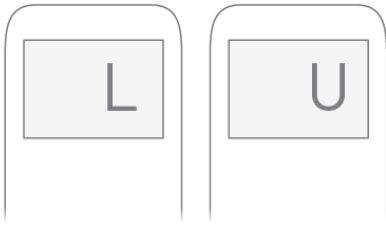

RESPONSE

LCD displays "L" when locked
LCD displays "U" when unlocked

1 Channel Remote



RESPONSE

LED solid on when locked
LED blinkina when unlocked

Select channel on controller.

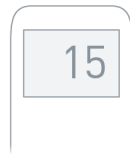

Hold P1 button on motor head.

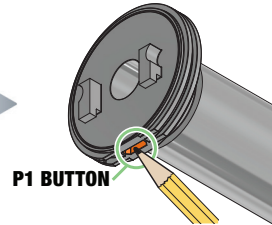

Hold STOP on controller.

! Must be done within 4 seconds of motor jog from P1 button.



! IMPORTANT

Consult user manual for your controller for information on selecting channel.

Motor Response



Motor Response



! Important: Motor is now in step mode and ready for setting limits.

P1 Button Functions

Motor state test: This table describes the function of a short P1 Button press/release (<2 seconds) depending on current motor configuration.

P1 Press	Condition	Function Achieved	Visual Feedback	Audible Feedback	Function Described
Short Press	If limit is NOT set	None	No Action	None	No Action
	If limits are set	Operational control of motor, run to limit. Stop if running.	Motor Runs	None	Operational control of motor after pairing and limit setting is completed first time.
	If motor is in "Sleep Mode" and limits are set	Wake and control	Motor wakes and runs in a direction.	None	Motor is restored from Sleep Mode and RF control is active.

Activate Pairing Mode



Sleep Mode

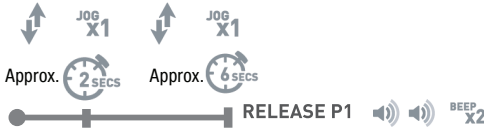

Reverse Direction

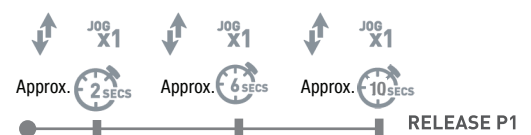

Reset to Factory Settings

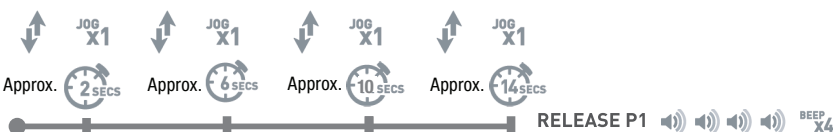

Section 7 - Motor Limits

! IMPORTANT
Cycle shade up and down prior to setting limits to settle fabric.

! IMPORTANT
Damage to shade may occur when operating motor prior to setting limits.
Attention should be given.

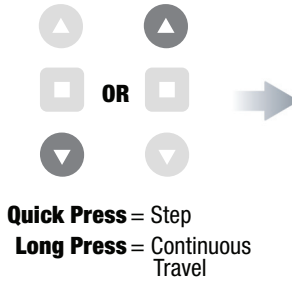

To reverse shade direction, hold both UP and DOWN until the motor responds.

! IMPORTANT
Reversing motor direction using this method is only possible during initial set-up.

Motor Response



Setting 5 Volt Motor Limits

! IMPORTANT
Cycle shade up and down prior to setting limits to settle fabric.

Move shade to the desired highest or lowest position by pressing the UP or DOWN buttons on controller.

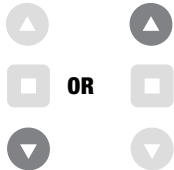

To save upper limit, hold UP and STOP.
To save lower limit, hold DOWN and STOP.



! IMPORTANT
After setting limits, motor will automatically exit from initial setup mode.

Motor Response



Adjusting 5 Volt Motor Limits

To adjust upper limit:

Hold UP & STOP for 1 jog & 1 beep.
Move shade to new upper limit.
Hold UP & STOP for 2 jogs & 3 beeps.

To adjust lower limit:

Hold DOWN & STOP for 1 jog & 1 beep.
Move shade to new lower limit.
Hold DOWN & STOP for 2 jogs & 3 beeps.

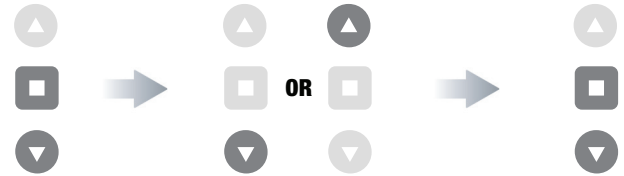

Motor Response



Motor Response



! IMPORTANT

The bottom limit should be set ~ 1.38 in. (35mm) below the Ultra-Lock to disengage the auto lock mechanism when the shade is raised.

Using P2 Button on existing controller to add a new controller or channel

A = Existing controller or channel (to keep)

B = Controller or channel to add or remove

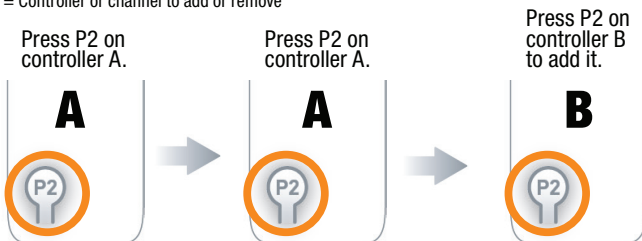

Motor Response



Motor Response



Motor Response



! IMPORTANT
Consult user manual for your controller or sensor.

Using an existing controller to add or delete a controller or channel

A = Existing controller or channel (to keep)

B = Controller or channel to add or remove

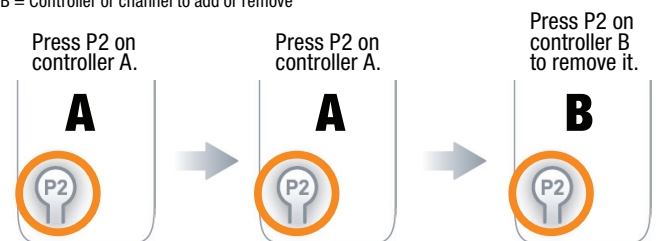

Motor Response



Motor Response



Motor Response



! IMPORTANT
Consult user manual for your controller or sensor.

Setting Favorite Position

Move shade to the desired position by pressing the UP or DOWN button on the controller.



Send Shade to Favorite Position



Press P2 on controller.



Motor Response



Press STOP on controller.



Motor Response



Press STOP on controller.



Motor Response



Deleting Favorite Position

Press P2 on controller.



Motor Response



Press STOP on controller.



Motor Response



Press STOP on controller.



Motor Response



Toggle Motor to Roller Mode

Default motor mode is Roller Mode (for use with roller shades) after initial Limits have been set. If motor is in Tilt Mode (for use with other product types), use the following steps to return to Roller Mode.

Hold UP and DOWN on controller.



Motor Response



Press STOP on controller.



Motor Response



Adjusting Motor Speed

Increase Motor Speed (Default motor mode is the slowest speed.)

Press P2 on controller.



Motor Response



Press UP.



Motor Response



Press UP.



Motor Response



Decrease Motor Speed

Press P2 on controller.



Motor Response



Press DOWN.



Motor Response



Press DOWN.



Motor Response



Stop Configuration

Turn Soft Stop OFF:
Motor must be in slowest speed to turn Soft Stop OFF.

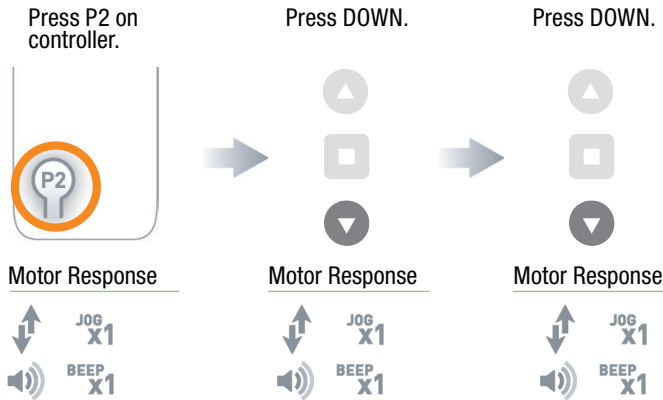

Turn Soft Stop ON:
Motor must be in fastest speed to turn Soft Stop ON.

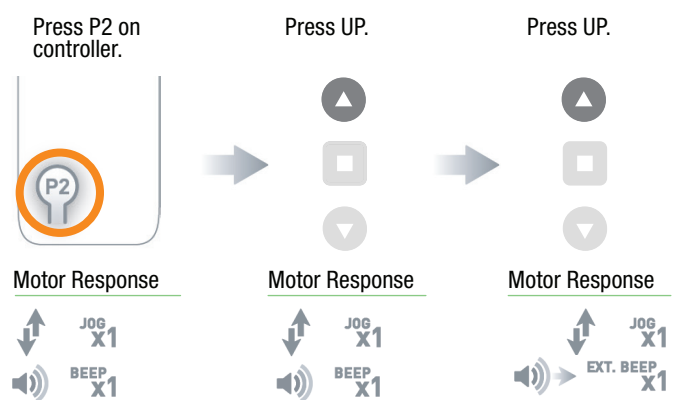

Battery Check Function

Send Shade to battery charge level.

IMPORTANT
Shade must be at Upper Limit.

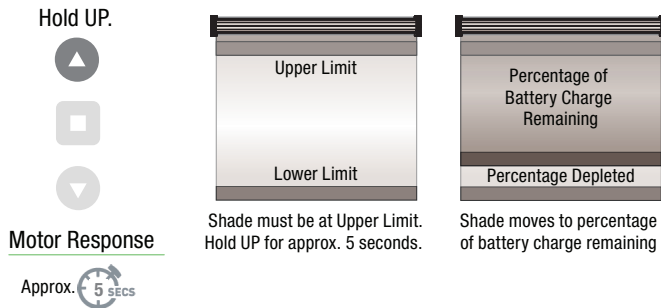

Charging LED

Turn Charging LED ON/OFF

IMPORTANT
Shade must be at Lower Limit.

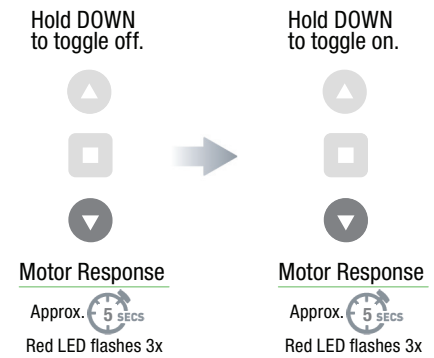

Sleep Mode

If multiple motors are grouped on a single channel, Sleep Mode may be used to put all but 1 motor to sleep, allowing programming of just the one motor that remains "Awake".

Enter Sleep Mode

Sleep mode is utilized to prevent a motor from incorrect configuration during other motor setup.

Hold P1 button on the motor head.



Exit Sleep Mode: Method 1

Exit sleep mode once the shade is ready.

Press and release P1 button on the motor head.



Exit Sleep Mode: Method 2

Remove power and then re-power the motor.

Troubleshooting

PROBLEM	CAUSE	REMEDY
Motor is not responding	Battery in motor is depleted	Recharge with a compatible charger
	Insufficient charging from solar PV panel	Check connection and orientation of PV panel
	Transmitter battery is discharged	Replace battery
Motor beeps x10 when in use	Battery is inserted incorrectly into transmitter	Check battery polarity
	Radio interference/shielding	Ensure transmitter is positioned away from metal objects and the aerial on motor or receiver is kept straight and away from metal
	Receiver distance is too far from transmitter	Move transmitter to a closer position
	Charging failure	Check power supply to motor is connected and active
Cannot program a single motor (multiple motors respond)	Battery voltage is low	Recharge with a compatible charger
	Multiple motors are paired to the same channel	Always reserve an individual channel for programming functions. Use Sleep Mode to program individual motors.

Section 8 - Bracket Dimensions

C002.1822 (Idler End, Extended)

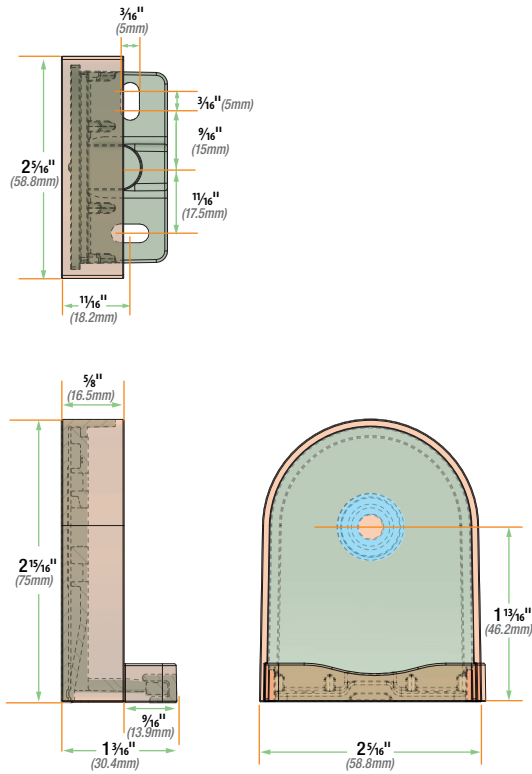

C002.1820 (Motor End, Extended)

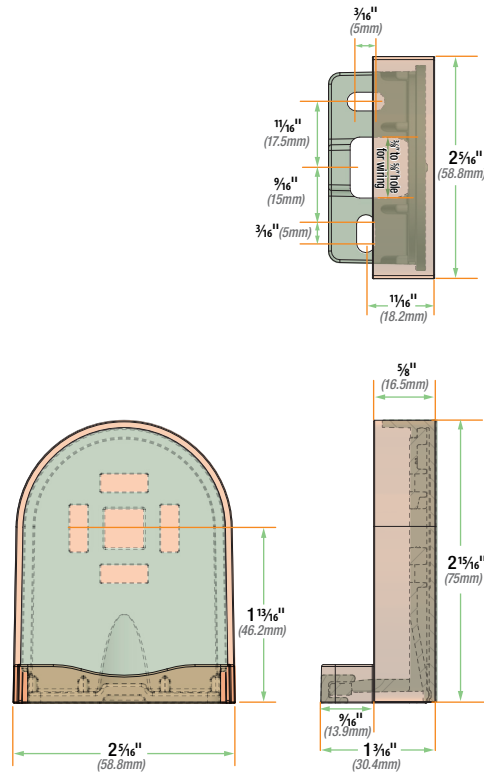

Section 9 - Shade Dimensions

