



Ondeis™ WireFree RTS Rain & Sun Sensor

EN Installer Manual



SOMFY SYSTEMS INC
SOMFY NORTH AMERICAN HEADQUARTERS
121 Herrod Blvd.
Dayton, NJ 08810
P: (800) 22-SOMFY (76639)
NJ: (609) 395-1300
F: (609) 395-1776

FLORIDA
6100 Broken Sound Pkwy. N.W.
Suite 14
Boca Raton, FL 33487
P: (800) 22-SOMFY (76639)
F: (561) 995-7502

CALIFORNIA
15291 Barranca Parkway
Irvine, CA 92618-2201
P: (800) 22-SOMFY (76639)
F: (949) 727-3775

SOMFY ULC
SOMFY Canada Division
5178 Everest Drive
Mississauga, Ontario L4W2R4
P: (800) 66-SOMFY (76639)
CN: (905) 564-6446
F: (905) 238-1491



Ondeis™ WireFree RTS Rain & Sun Sensor Overview

- Works with all Radio Technology Somfy® (RTS) exterior motors and Universal RTS Receiver
- Single channel combination rain and sun sensor
- Solar powered rechargeable battery
- Adjustable rain and sun thresholds
- Six different operation modes, Demo mode
- Flexible installation options
- Status LEDs for visual feedback
- Rain commands always take priority
- Operational temperature: 32°F/0°C to 140°F/60°C
- IP Rating: IP55

What is in the box:

1. Ondeis™ WireFree RTS Rain & Sun Sensor with a mounting plate and 2 round head wood screws
2. Gutter mount:
 - 1 Aluminum gutter-mount bracket
 - 2 Socket head screws
 - 2 Flat head screws
 - 2 Nylon locking nuts

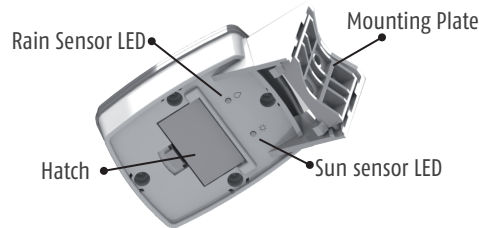
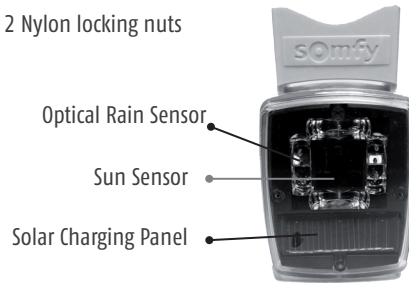

LED Behavior

Normal Operation

- Blinks every 5 seconds when conditions are above the threshold

Demo Mode

- Alternate blinks when entering demo mode
- Blinks continuously when conditions are above the threshold
- Blink together when exiting demo mode

GETTING STARTED

1) Charge the sensor.

a. 10 minutes in direct sunlight will provide operation charge.

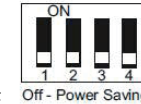

b. For most efficient charging, open hatch and move all switches to the OFF position.

2) Confirm RTS motorized window coverings are operating properly from an RTS control. The UP command should send the awnings IN and screens/shutters UP.
(To change the direction please follow the awning instructions)

3) Choose sensor operation mode. The default setting is Awning Rain. For detailed explanations of operation modes, refer to Operation Modes on reverse.

NOTE: A Soliris transmitter (1810647 or 1811243 – not included) is required for Awning Sun and Awning Rain & Sun operation modes.

4) Select sensor threshold settings

a. Factory Default:

- Rain: 9 o'clock (arrow pointing left)
- Sun: 12 o'clock (arrow pointing up)

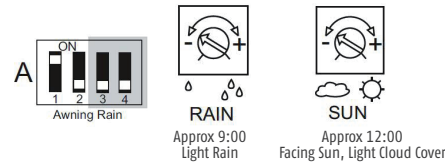

b. More sensitive: turn left

- Very light rain/heavy mist/heavy condensation
- Heavy cloud cover (.5 klux)

c. Less sensitive: turn right

- Very heavy rain
- Direct summer sun, no cloud cover (55 klux)

5) Program the sensor to the motor(s)

Step 1: Press the programming button on the RTS transmitter to put the motor into programming mode – motor will jog.

Step 2: Press the sensor's programming button – motor will jog again.

Deleting the sensor - Repeat steps 1 and 2 above.

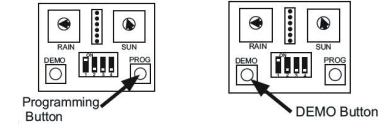

6) To confirm settings, put sensor into demo mode to test rain/sun sensing without standard wait times.

a. Briefly press and release "Demo" button. The associated motor(s) will jog and the sensor's LEDs will alternate blinks.

b. Demo mode will time out after 2 minutes. To exit demo mode, press the Demo button again.

SENSOR TIME DELAYS

	DEMO Mode	Normal Mode
Rain present	0 sec (UP-Locked)	0 sec (UP-Locked)
Rain absent	3 sec (Unlocked)	5 min (Unlocked)
Sun present	10 sec (DOWN)	2 min (DOWN)
Sun absent	15 sec (UP)	15-30 min (UP)

7) Mount the sensor for maximum exposure to rain and/or sun.

a. For best sun protection, sensor should be mounted facing same direction as the associated motorized window coverings.

b. For best rain protection, sensor should be exposed to as much rain as possible.

c. There are three different mounting options possible using included mounting plate and bracket: vertical mount, pole mount (using zip ties, not included) and gutter mount.

Pole and Wall Mount

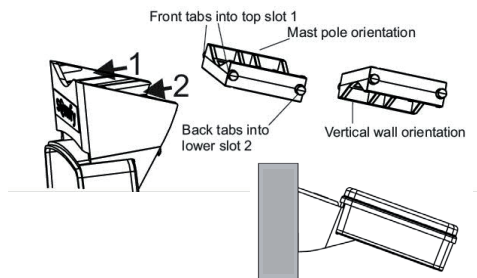

7) Mount the sensor (continued)

The mounting bracket is released by pushing the bracket clips down gently towards the main body of the sensor and sliding out the mounting bracket.

To replace the mounting bracket, press the bracket clips down gently towards the main body of the sensor and slide in the mounting bracket, making sure the front tabs move into the top slot and the back tabs into the lower slot.

NOTE: The sensor does NOT operate under 32°F/0°C; standing water, snow or frost DOES NOT activate sensor.

Gutter Mount

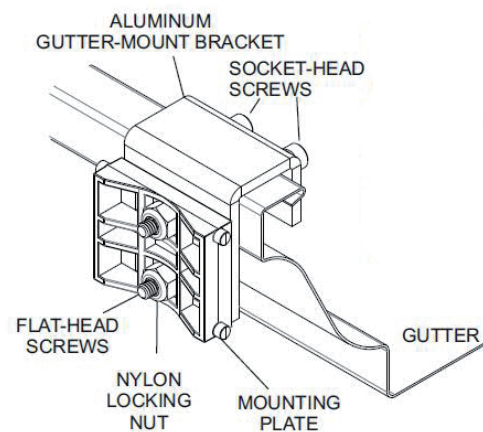

Securely attach rain sensor mounting plate to aluminum gutter mount bracket using flat head screws and nylon locking nuts. Slide gutter mount bracket over gutter lip and secure with socket-head screws.

NOTE: If the sensor is removed from a job site, it must be deleted from the motor's memory. If the sensor is removed from the jobsite while in a sensor mode, the awning will retract at regular intervals.

The sensor must **ALWAYS** be deleted from the motor's memory before removing from the job site OR switching between awning and shutter/screen modes.

OPERATION MODES

Important: A programmed sensor must be deleted from the motor's memory before it is changed between Awning or Shutter/Screen mode. Do not change between Awning and Shutter/Screen modes without deleting the sensor from the motor's memory first (to delete the sensor see step 5).

Awning Modes (Sensor Modes):

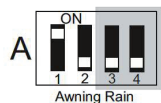

A. Awning Rain (factory default)

- Rain over threshold: sends awning in
- Awning is locked until 5 minutes after last rain over threshold detected

NOTE: Standing water, snow or frost DOES NOT lock the sensor.

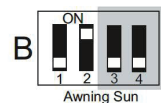

B. Awning Sun

NOTE: A Soliris transmitter (1810647 or 1811243 – not included) is required to activate the motor's sun function.

- Sun over threshold (for 2 minutes): sends awning out
- Sun under threshold (for 15-30 minutes): sends awning in

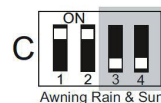

C. Awning Rain & Sun

NOTE: A Soliris transmitter (1810647 or 1811243 – not included) is required to activate the motor's sun function

- Rain over threshold: sends awning in
- Awning is locked until 5 minutes after last rain over threshold detected, even to Sun commands
- Sun over threshold (for 2 minutes): sends awning out
- Rain & Sun over threshold: sends awning in
- Rain & Sun under threshold (for 15-30 minutes): sends awning in

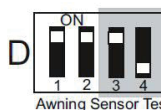

D. Awning Sensor Test

Allows testing of the sensor programmed to the motor. In this mode, pressing the DEMO button will extend the awning. This mode is for testing only. Do not leave the unit in this mode for normal operation.

Shutter/Screen Modes (Transmitter Modes):

Remove switch sticker to access shutter settings

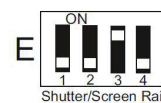

E. Shutter/Screen Rain

- Rain over threshold: sends shutters/screens down
- Rain doesn't lock the motor – transmitter commands will still work.
- Will not send another command until rain falls below the threshold for 5 min and then goes above again

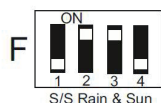

F. Shutter/Screen Rain & Sun

- Rain over threshold: sends shutters/screens down
- Shutter/screen will lock out sun commands until 5 minutes after last rain over threshold is detected; transmitter commands will still work
- Sun over threshold (for 2 minutes): sends shutters/screens down
- Sun under threshold (for 15 minutes): sends shutters/screens up

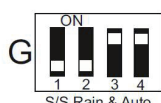

G. Shutter/Screen Rain & Auto Up

- Rain over threshold: sends shutters/screens down
- Rain doesn't lock the motor – transmitter commands will still work
- Rain under threshold (for 5 minutes): sends shutters/screens up

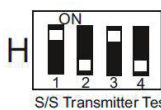

H. Shutter/Screen Transmitter Test

Allows testing of the sensor programmed to the motor. In this mode, pressing the DEMO button will send a down transmitter command. This mode is for testing only. Do not leave the unit in this mode for normal operation.

Non-functional Dip Switch settings. Do not use the following Dip Switch configurations:

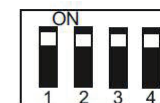
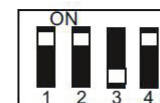
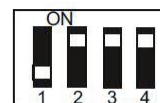

This device complies with Part 15 of the FCC Rules. Operation is subject to the following conditions

- This device may not cause harmful interference and
- This device must accept any interference received, including interference that may cause undesired operation

Warning! Changes or modifications not expressly approved by the manufacturer could void the users authority to operate the equipment.