

StyleLine

Fixed screen with bezel trim or borderless option

SUBMITTAL

TECHNICAL INFO

Specifications

_____ Permanently mounted fixed frame projection screens, size _____ h. x _____ w. (viewing area), designed for wall mounting. Sub Frame shall be .065 inch thick 6063 aluminum. Frame equipped with mounting flange to interface with Z-Clip wall mounting brackets. 1/2" (13 mm) back lip on frame to accept LED light strip (by others). Base trim frame extrusions provide for up to 1 3/8" (35 mm) of horizontal and vertical surface tension adjustability. Screen viewing surface is 2 3/8" (56mm) from mounting surface.

FRAME OPTIONS:

Bezel Frame: [5/8" (16 mm)] [3 3/8" (81 mm)] black Vel-Tex covered extruded aluminum bezel trim frame visible from the front.

Borderless Frame: Sub frame shall be completely hidden by the projection viewing surface.

Viewing Surface: To attach to frame using using a continuous hook & loop attachment. Matt White XT1000VB and Grey XH600V viewing surfaces are certified to GREENGUARD standards for low chemical emissions into indoor air during product usage. For more information, visit ul.com/gg.



DOWNLOADABLE 3-PART SPECIFICATIONS:

Available at www.draperinc.com

Please note: Dimensions of hardware at manufacturer's discretion.

Select Image Size, Frame Edge Option and Quantity.

16:10 Format						
Nominal Diagonal	Image Size	Overall H" x W", Borderless Qty.	Overall H" x W", 5/8" Vel-Tex Bezel Qty.	Overall H" x W", 3 3/8" Vel-Tex Bezel Qty.		
94"	50" x 80"	<input type="checkbox"/> 50" x 80"	<input type="checkbox"/> 51 1/4" x 81 1/4"	<input type="checkbox"/> 56 3/8" x 86 3/8"		
109"	57 1/2" x 92"	<input type="checkbox"/> 57 1/2" x 92"	<input type="checkbox"/> 58 3/4" x 93 1/4"	<input type="checkbox"/> 63 7/8" x 98 3/8"		
113"	60" x 96"	<input type="checkbox"/> 60" x 96"	<input type="checkbox"/> 61 1/4" x 97 1/4"	<input type="checkbox"/> 66 3/8" x 102 3/8"		
123"	65" x 104"	<input type="checkbox"/> 65" x 104"	<input type="checkbox"/> 66 3/4" x 105 1/4"	<input type="checkbox"/> 71 7/8" x 110 3/8"		
137"	72 1/2" x 116"	<input type="checkbox"/> 72 1/2" x 116"	<input type="checkbox"/> 73 3/4" x 117 1/4"	<input type="checkbox"/> 78 3/8" x 122 3/8"		
165"	87 1/2" x 140"	<input type="checkbox"/> 87 1/2" x 140"	<input type="checkbox"/> 88 3/4" x 141 1/4"	<input type="checkbox"/> 93 7/8" x 146 3/8"		
16:9 HDTV Format						
Nominal Diagonal	Image Size	Overall H" x W", Borderless Qty.	Overall H" x W", 5/8" Vel-Tex Bezel Qty.	Overall H" x W", 3 3/8" Vel-Tex Bezel Qty.		
92"	45" x 80"	<input type="checkbox"/> 45" x 80"	<input type="checkbox"/> 46 1/4" x 81 1/4"	<input type="checkbox"/> 51 3/8" x 86 3/8"		
100"	49" x 87"	<input type="checkbox"/> 49" x 87"	<input type="checkbox"/> 50 1/4" x 88 1/4"	<input type="checkbox"/> 55 3/8" x 93 3/8"		
106"	52" x 92"	<input type="checkbox"/> 52" x 92"	<input type="checkbox"/> 53 1/4" x 93 1/4"	<input type="checkbox"/> 58 3/8" x 98 3/8"		
110"	54" x 96"	<input type="checkbox"/> 54" x 96"	<input type="checkbox"/> 55 1/4" x 97 1/4"	<input type="checkbox"/> 60 3/8" x 102 3/8"		
119"	58" x 104"	<input type="checkbox"/> 58" x 104"	<input type="checkbox"/> 59 1/4" x 105 1/4"	<input type="checkbox"/> 64 3/8" x 110 3/8"		
133"	65" x 116"	<input type="checkbox"/> 65" x 116"	<input type="checkbox"/> 66 1/4" x 117 1/4"	<input type="checkbox"/> 71 3/8" x 122 3/8"		
161"	79" x 140"	<input type="checkbox"/> 79" x 140"	<input type="checkbox"/> 80 1/4" x 141 1/4"	<input type="checkbox"/> 85 3/8" x 146 3/8"		
2.39:1 SCOPE Format						
Nominal Diagonal	Image Size	Overall H" x W", Borderless Qty.	Overall H" x W", 5/8" Vel-Tex Bezel Qty.	Overall H" x W", 3 3/8" Vel-Tex Bezel Qty.		
90"	35" x 83 1/2"	<input type="checkbox"/> 35" x 83 1/2"	<input type="checkbox"/> 36 1/4" x 84 3/4"	<input type="checkbox"/> 41 3/8" x 89 3/8"		
116"	45" x 107 1/2"	<input type="checkbox"/> 45" x 107 1/2"	<input type="checkbox"/> 46 1/4" x 108 3/4"	<input type="checkbox"/> 51 3/8" x 113 3/8"		
135"	52" x 124"	<input type="checkbox"/> 52" x 124"	<input type="checkbox"/> 53 1/4" x 125 1/4"	<input type="checkbox"/> 58 3/8" x 130 3/8"		
150"	58" x 138 1/2"	<input type="checkbox"/> 58" x 138 1/2"	<input type="checkbox"/> 59 1/4" x 139 3/4"	<input type="checkbox"/> 64 3/8" x 144 3/8"		
21:9 Ultrawide Format						
Nominal Diagonal	Image Size	Overall H" x W", Borderless Qty.	Overall H" x W", 5/8" Vel-Tex Bezel Qty.	Overall H" x W", 3 3/8" Vel-Tex Bezel Qty.		
104 1/4"	40 1/4" x 96"	<input type="checkbox"/> 40 1/4" x 96"	<input type="checkbox"/> 41 1/2" x 97 1/4"	<input type="checkbox"/> 46 3/8" x 102 3/8"		
126"	49" x 116"	<input type="checkbox"/> 49" x 116"	<input type="checkbox"/> 50 1/4" x 117 1/4"	<input type="checkbox"/> 55 3/8" x 122 3/8"		
152"	59" x 140"	<input type="checkbox"/> 59" x 140"	<input type="checkbox"/> 60 1/4" x 141 1/4"	<input type="checkbox"/> 65 3/8" x 146 3/8"		
Custom Size						
Nominal Diagonal	Image Size	Overall H" x W", Borderless	Overall H" x W", 5/8" Vel-Tex Bezel	Overall H" x W", 3 3/8" Vel-Tex Bezel		
		<input type="checkbox"/>	<input type="checkbox"/>	<input type="checkbox"/>		

Please Mark Appropriate Selections.

Select Frame Options:

- No Bezel (Borderless)
- 5/8" (16mm) Bezel (Black Vel-Tex textile covering standard)
- 3 3/8" (81mm) Bezel (Black Vel-Tex textile covering standard)

Select Viewing Surface:

- TECVISION** Premium Optical Surface

Choose TecVision® surface:

- XT1000X White (1.0 gain) Certified
- XT1100X White (1.1 gain) Certified
- XT1300X White (1.3 gain) Certified
- XT1600X White (1.6 gain) Certified
- XH700X Grey (0.7 gain) Certified
- XH1200X Grey (1.2 gain) Certified
- XH800X ALR (0.8 gain) Certified
- XH900X ALR (0.9 gain) Certified
- MS1000X ALR (1.0 gain) Certified
- CS1100X ALR (1.1 gain) Certified
- Other

- I want the above **TECVISION** surface perforated.

Choose standard viewing surface:

- Matt White XT1000VB* (1.0 gain): GREENGUARD Gold certified
- Grey XH600V (0.6 gain) (Thru 9' x 12'): GREENGUARD Gold certified
- Clearsound Nanoperf XT1000V (1.0 gain)
- Other



Draper, Inc. | 411 S. Pearl St. Spiceland, IN 47385
draperinc.com | 765.987.7999 | 800.238.7999

© 2024 All Rights Reserved | FORM: StyleLine_Sub24-R2

PROJECT: _____

ARCHITECT: _____

CONTRACTOR: _____

SUPPLIER: _____

DATE: _____ REVISED: _____

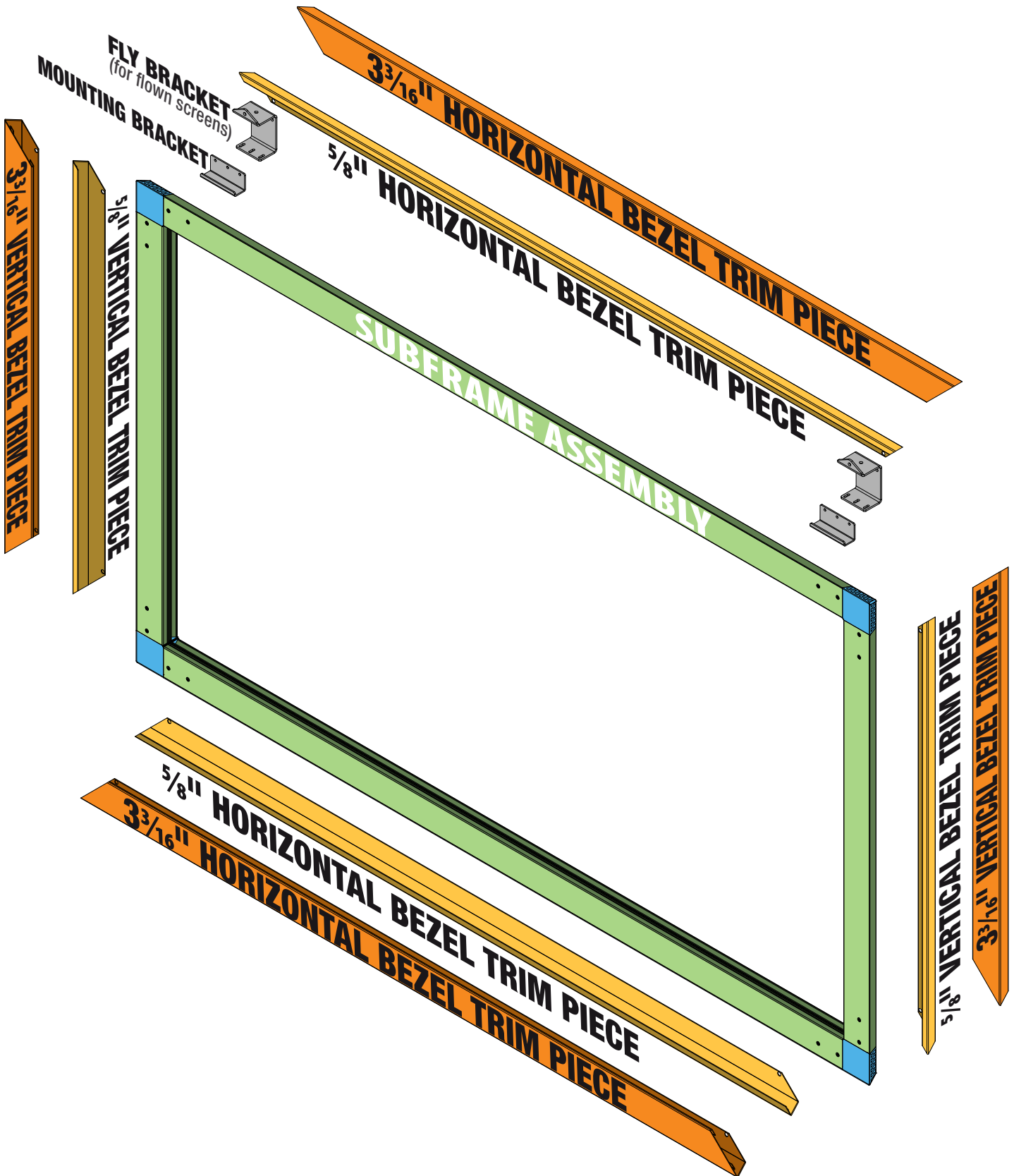

Dimensions

$\frac{5}{8}$ " (16mm) BEZEL STYLELINE

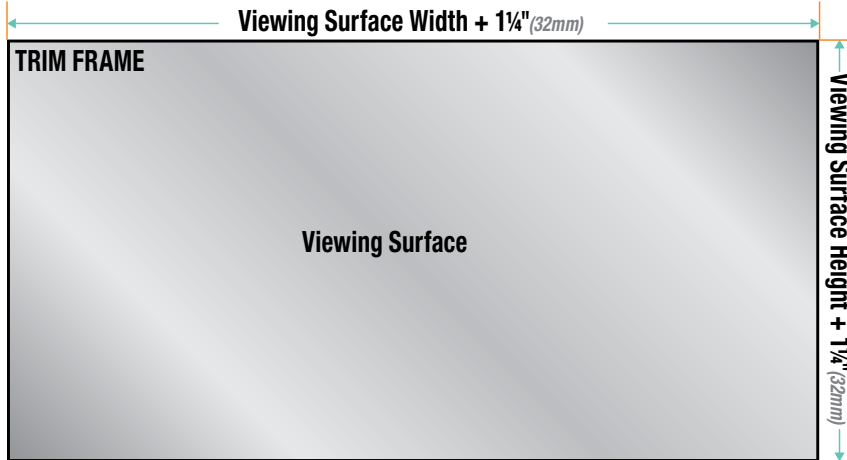

$\frac{5}{8}$ " BEZEL WALL MOUNT

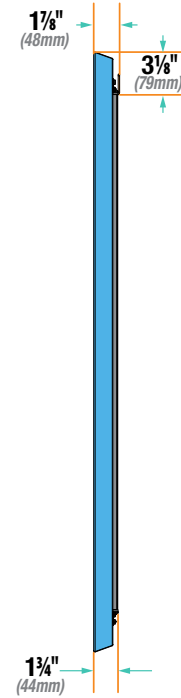

$\frac{5}{8}$ " BEZEL FLOWN

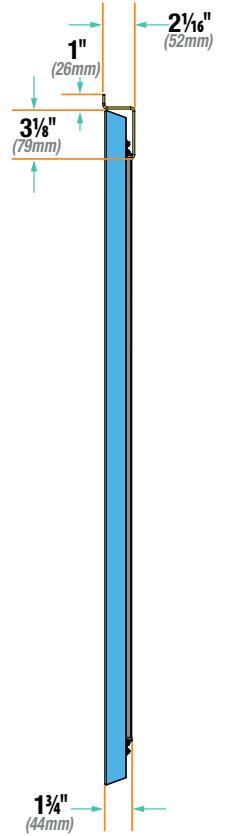

$3\frac{3}{16}$ " (81mm) BEZEL STYLELINE

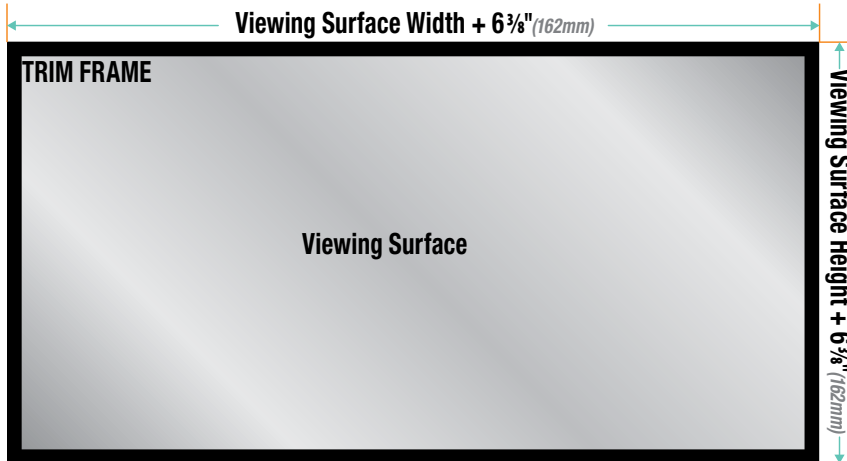

$3\frac{3}{16}$ " BEZEL WALL MOUNT

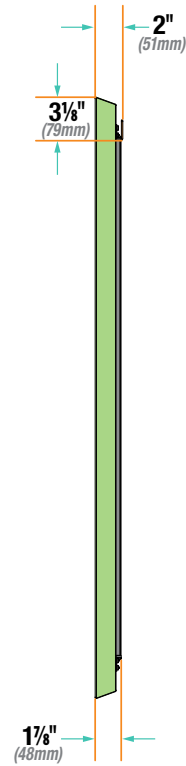

$3\frac{3}{16}$ " BEZEL FLOWN

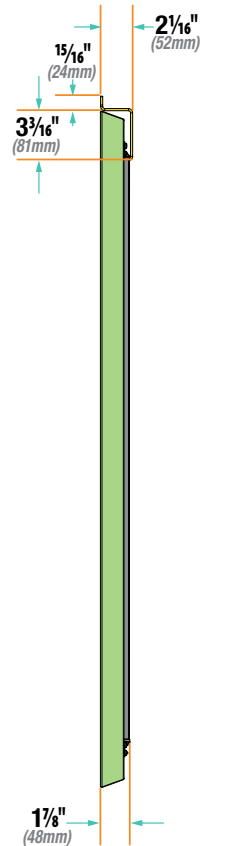

Dimensions (continued)

BORDERLESS STYLELINE

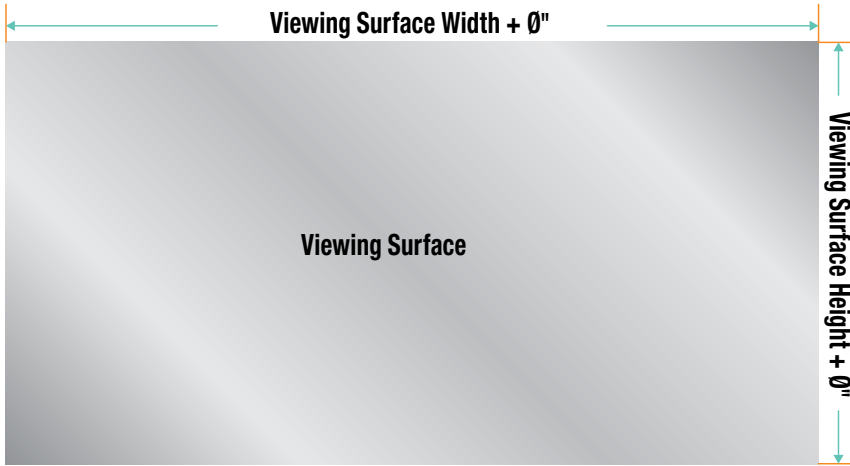

BORDERLESS WALL MOUNT

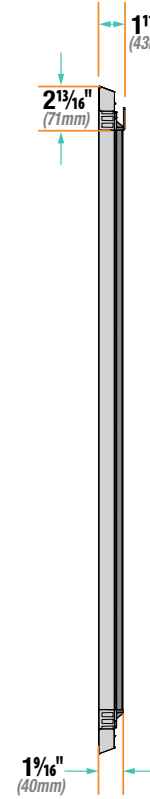

BORDERLESS FLOWN

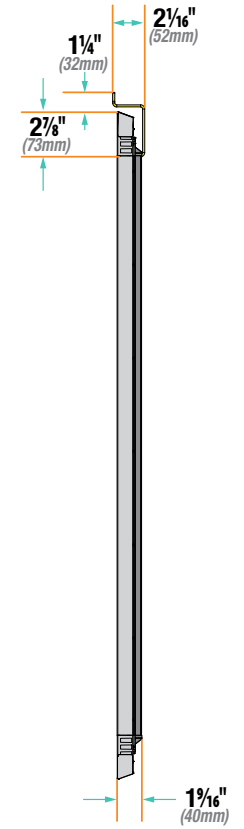

Mounting Bracket Dimensions

Wall Mounting Bracket

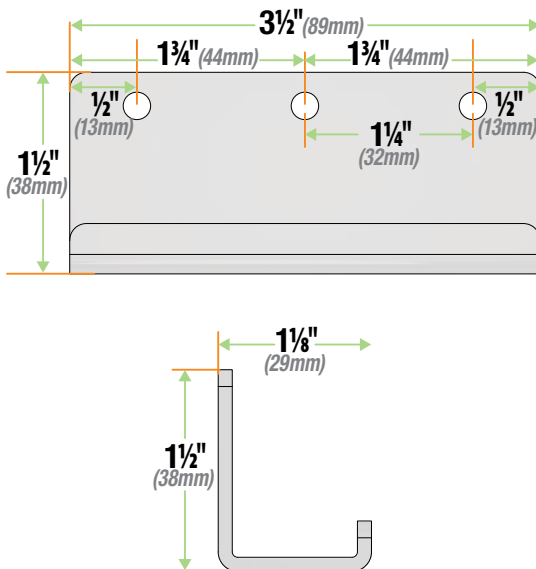

Mounting Bracket for flown screens

