

Assembly/Installation Instructions Universal Projector Mount by Draper

Assembling Universal Projector Mount

① Locate the following parts:

- Projector Mounting Plate - **QTY 1**
- Long Slotted Arm - **QTY 2**
- Short Slotted Arm - **QTY 4**
- Machine Screws:
 - $\frac{5}{16}$ -18 x $1\frac{1}{4}$ " - **QTY 1**
 - $\frac{1}{4}$ -20 x 2" - **QTY 4**
 - M3 x 0.5 x 30mm Hex Head - **QTY 4**
 - M4 x 0.7 x 30mm Hex Head - **QTY 4**
 - M5 x 0.8 x 30mm Hex Head - **QTY 4**
 - M6 x 1.0 x 30mm Hex Head - **QTY 4**
- Washers:
 - .375 ID x .875 OD x .064" - **QTY 5**
 - .255 ID x .562 OD x .060" - **QTY 4**
- $\frac{5}{16}$ " Locking Nut - **QTY 1**
- Compression Springs - **QTY 4**
- Nylon Spacers (various lengths) - **QTY 4**

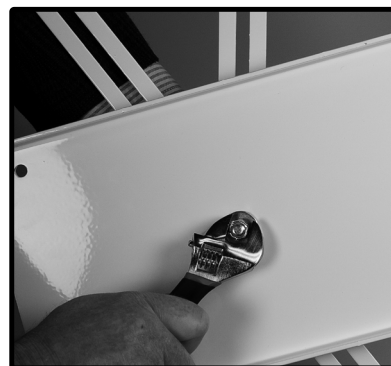
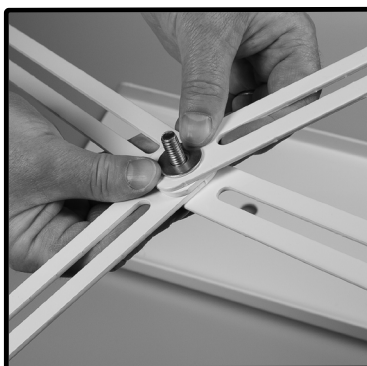
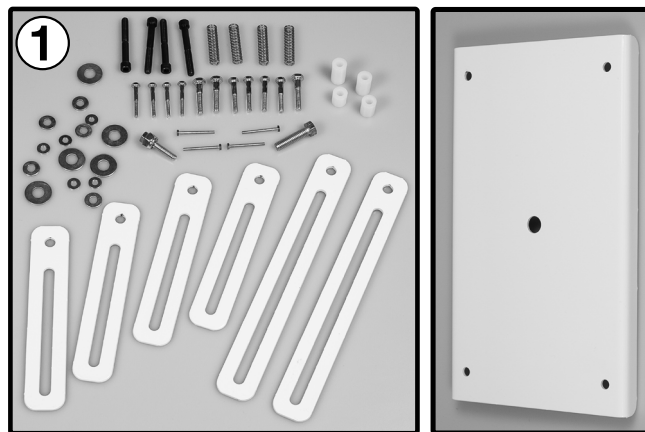

② Thread the following: **Washer** (.375 ID x .875 OD x .064"), **Two (2) Long Slotted Arms**, **Two (2) Short Slotted Arms**, and a second **Washer** (.375 ID x .875 OD x .064") onto the $\frac{5}{16}$ -18 x $1\frac{1}{4}$ " **Machine Screw**.

Thread this assembly through the hole in the center of the **Projector Mounting Plate** and secure with a third **Washer** (.375 ID x .875 OD x .064") and the $\frac{5}{16}$ " **Locking Nut** (See photo sequence ②).

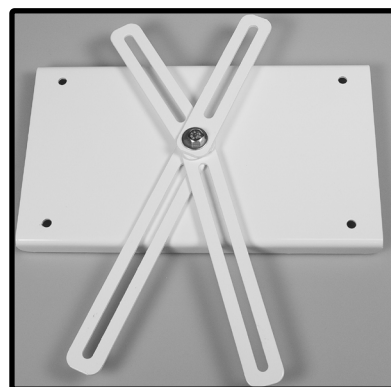

③ Thread the four (4) $\frac{1}{4}$ -20 x 2" **Machine Screws with Washer** (.255 ID x .562 OD x .060") through the holes in the corner of the **Projector Mount Plate** and secure them in place with the four (4) **Compression Springs** (See photo sequence ③).

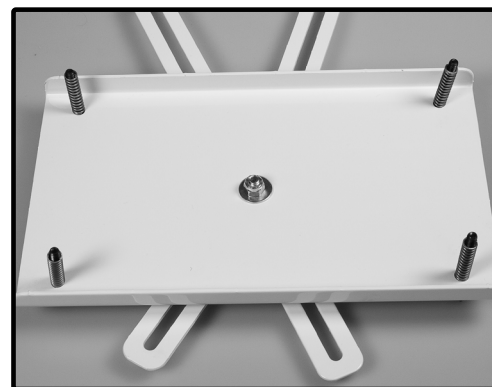
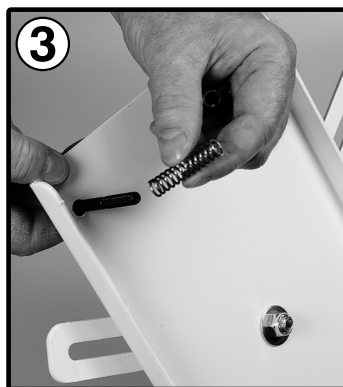

DRAPER

Continued on next page

Installing Projector Using Universal Projector Mount

- ① If the projector will be installed in a lift, attach the Universal Projector Mount to the projector pan. See Fig. ① at right).

Please Note:

Consult the installation manual provided with the lift for detailed instructions on how to properly attach your Universal Projector Mount to the projector pan.

- ② Determine which size mounting bolts suit your projector (M3, M4, M5 or M6), and set others aside. They are no longer required. If your projector has only three mounting holes, remove one of the mounting arms (see photo ② at right).
- ③ Spread out the arms so each end is over one of the mounting holes in the projector. Use the provided **nylon spacers** to ensure the projector will be mounted level with the Projector Mounting Plate (see photo ③ at right).
- ④ Connect projector to the mounting arms and tighten the mounting bolts.

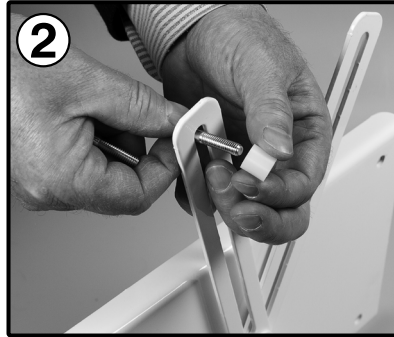
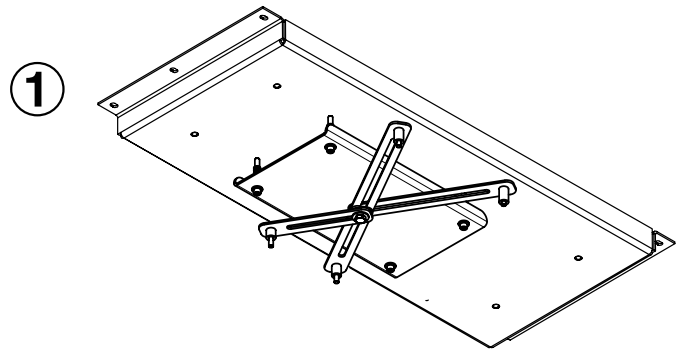

Making Adjustments

Roll & Tilt: Use the ¼" (6.35 mm)-20 bolts and springs which hold the rectangular plate to the bottom pan (the springs will ensure that the projector is held still during motion).

Yaw: Adjust the center 5/16" (8 mm) bolt).

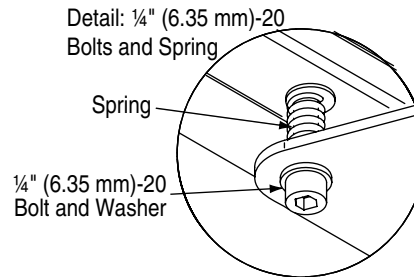

Universal Projector Mount Dimensions

